



**AIRAM**

Koristevalot | Dekorationsbelysning | Decorative Lights 2019

# SISÄLTÖ | INNEHÅLL | INDEX



8-9  
Roosa nauha  
Rosa bandet  
Pink Ribbon  
12-15  
Itsenäisyyspäivä  
Självständighetsdagen  
Independence Day



16-33  
Valolangat  
Ljusslingor  
Light wires

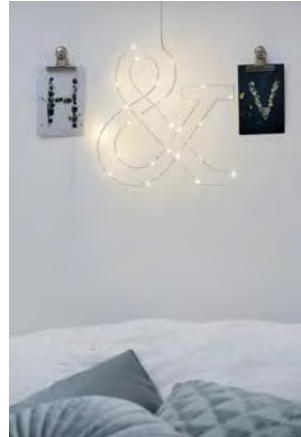

34-61  
Koristevalot sisustukseen,  
kattaukseen ja koristeluun  
Dekorationsbelysning för  
inredning, dukningar och  
dekorationer  
Lights for Interior, Table Setting  
and Decoration



62-69  
Puuvillapallot ja pallosarjat  
Bomullsbollar och bollserier  
Cotton balls and ball series

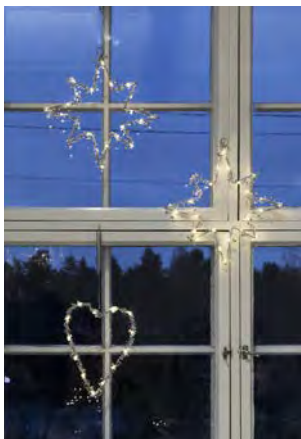

70-83  
Ikkuna- ja seinäkoriisteet  
Fönster- och väggdekorationer  
Window and Wall Decorations



84-93  
Paperikoristeet  
Pappersdekorationer  
Paper Decorations



94-101  
Lasikoristeet  
Glasdekorationer  
Glass Ornaments



102-129  
LED-kynttilät, -lyhdyt ja  
-kyntteliköt  
LED-ljus, -lyktor och -ljusstakar  
LED Candles, Lanterns and  
Candelabra



130-135  
Joulupukki suosittelee  
Julmoten rekommenderar  
Recommended by Santa Claus



136-145  
Kuusenkynttilät ja latvatähdet  
Julgransbelysning och  
toppstjärnor  
Christmas Tree Candles and  
Tree Top Stars



146-159  
Led-sarjat (IP44)  
LED-slingor (IP44)  
LED Sets (IP44)



160-171  
Lamppusarjat  
Lampslingor  
Light Sets



172-177

Narukoristeet  
Repprodukter  
Products of Rope



178-193

Jääpuikot, verhot, latvasarjat,  
verkot (IP44)  
Istappar, gardiner, toppsinglor,  
nät (IP44)  
Icicles, Curtains, Tree top sets,  
Nets (IP44)



194-199

Jatkettavat valosarjat (IP44)  
Förlängbara ljusslingor (IP44)  
Connectable LED Sets (IP44)



200-224

Puut, eläinhahmot,  
valohehikot (IP44)  
Träd, djurfigurer, ljusram (IP44)  
Trees, Animal Figures, Light  
frames (IP44)



202-208

Puut  
Träd  
Trees



209-217

Eläinhahmot  
Djurfigurer  
Animal figures



218-224

Valokehikot  
Ljusram  
Light frames



225-229

Valoprojektorit  
Ljusprojektorer  
Light Projectors



230-252

Solar



253

Varalamput  
Reservlampor  
Spare bulbs

254-257

Aakkosellinen hakemisto  
Alfabetisk innehållsförteckning  
Alphabetical table of contents

258

Yhteystiedot  
Kontakt  
Contact

259

Symbolit  
Symboler  
Symbols

# AIRAM SEASON 2019

16-33  
VALÖLANGAT  
LJUSSLINGOR  
LIGHT WIRES

202-208  
PUUT  
TRÄD  
TREES

102-127  
LED-KYNTTILÄT, -LYHDYT JA -KYNTTELIKÖT  
LED-LJUS, -LYKTOR OCH -LJUSSTAKAR  
LED CANDLES, LANTERNS AND CANDELABRA

209-217  
ELÄINHAHMOT  
DJURFIGURER  
ANIMAL FIGURES





218-224  
VALOKEHIKOT  
LJUSRAM  
LIGHT FRAMES



160-171  
LAMPPUSARJAT  
LAMPSLINGOR  
LIGHT SETS



225-229  
VALOPROJEKTORIT  
LJUSPROJEKTORER  
LIGHT PROJECTORS

### VALOJA, JOTKA KORISTAVAT VUODEN JOKAISTA PÄIVÄÄ.

Täydellisimpäänkin päivään mahtuu lisää valonpisaroita. Näin me Airamilla uskomme. Airam on jo vuosikymmeniä tehnyt joulun, mutta sen lisäksi piristämme vuoden jokaista päivää. Tästä kirjasta löydät jotain uutta, jotain vanhaa ja paljon sinistä. Syty koristelemaan kanssamme koko vuosi!

### LJUS SOM GÖR ALLA ÅRETS DAGAR VACKRA.

Även den mest perfekta dagen rymmer fler ljusglimtar. Det är vi på Airam övertygade om. Airam har redan i årtionden gjort julen, men dessutom piggar vi upp varje dag även under resten av året. I den här boken hittar du någonting nytt, någonting gammalt och mycket blått. Bli inspirerad och dekorera året om tillsammans med oss!

### LIGHTS THAT BRIGHTEN UP EACH DAY OF THE YEAR.

Even the most perfect day can always fit more sparkles of light. That is what we believe at Airam. For decades, Airam has brought Christmas, but we also want to brighten up the rest of the year. In this booklet, you will find something new, something old and a lot of blue. Light up the whole year with us!



SYYSKAUDEN TEEMATUOTTEET

Höstsäsongens produkter  
Products for autumn season

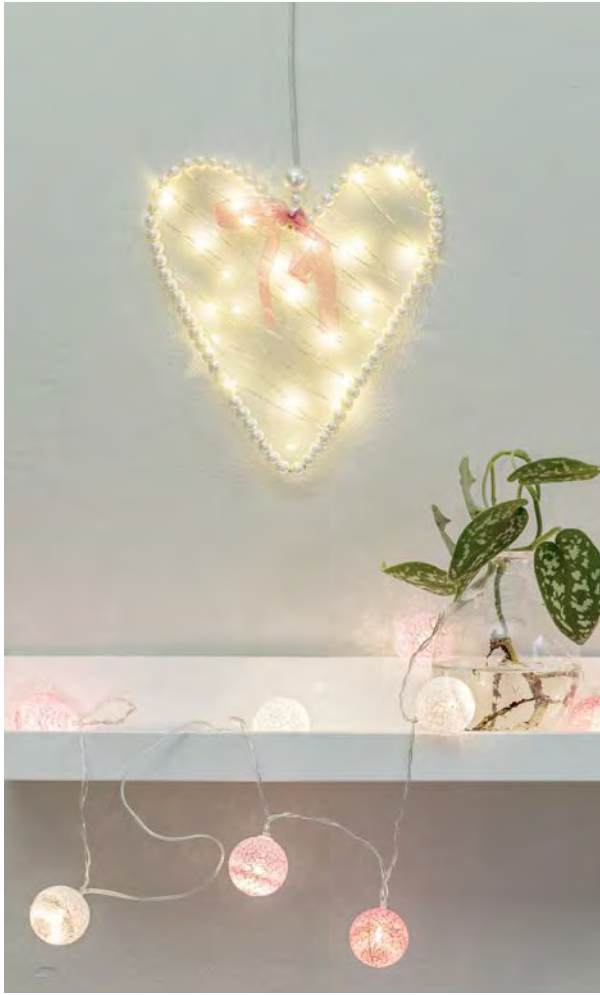

### ELÄKÖÖN NAISET!

Airamın Roosa nauha -tuotteilla ilahdutat helposti ystävää tai itseäsi. Roosa nauha -tuotteiden myynnistä kertyvällä tuotolla Syöpäsäätiö tukee suomalaista rintasyöpätutkimusta. Tuotteet ovat myynnissä vain Suomessa.

### LÄNGE LEVE KVINNORNA!

Med Airams Rosa bandet-produkter gläder du enkelt en vän eller dig själv. Med vinsten från försäljningen av Rosa bandet-produkterna stödjer Cancerstiftelsen den finländska bröstcancerforskningen. Produkterna säljs endast i Finland.

### LONG LIVE WOMEN!

Airam's Pink Ribbon products are an easy way to cheer up a friend or yourself. The profit from the sales of the Pink Ribbon products is used by the Cancer Foundation Finland to support Finnish breast cancer research. The products are only available in Finland.

### KIRKKAASTI KULMAKUNNAN KOMEIN KURPITSA!

Huhuu! Virittäydy hetkessä haamuyön tunnelmaan. Tuttujen halloween-koristevalojen lisäksi löydät valikoimasta uudet isot kurpitsat. Karkki vai kepponen?

### HELT KLART KVARTERETS STÅTLIGASTE PUMPA!

Buuu! Kom snabbt i rätt stämning inför spöknatten. Förutom de bekanta dekorationsljusen med Halloween-tema hittar du nya, stora pumpor i sortimentet. Bus eller godis?

### BY FAR THE PRETTIEST PUMPKINS ON THE BLOCK!

Boo! Create the perfect All Hallows' Eve atmosphere in minutes. In addition to the familiar Halloween decorations, our range now includes new large pumpkins. Trick or treat?



### 102 SYYTÄ SINIVALKOISEEN JUHLAVALAISTUKSEEN.

Hyvää ja turvallista itsenäisyyspäivää! T. Airam.

### 102 SKÅL TILL EN BLÅVIT FESTBELYSNING.

Glad och trygg självständighetsdag! Ö. Airam

### 102 REASONS TO CELEBRATE WITH BLUE AND WHITE

Wishing you a happy and safe Independence Day, Airam.



## ROOSA NAUHA LANKAPALLOT

### KORISTESARJA

Kauniit, ohuella puuvillalangalla päällystetyt pallot hehkuvat vaaleanpunaisen eri sävyissä. LED lämmin valkoinen, ei vaihdettava, kytketty 10 LEDin sarjaan. Sisältää paristot. Johto kirkas. On/off-kytkin.

### ROSA BANDET DEKORATIONSSLINGA

Vackra bollar beklädda med tunt bomullssnöre som lyser i olika nyanser av rosa. Varmvita LED-lampor, ej utbytbara, kopplade i serie om tio lampor. Batterier medföljer. Genomsiktig sladd. Av/på-knapp.

### PINK RIBBON COTTON BALL SERIES

These beautiful spheres covered with a thin cotton thread glow in various hues of pink. LED warm white, non-replaceable, connected with 10 LEDs in a series. Batteries included. Clear cord. On/off switch.

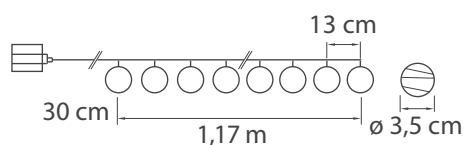

Nr 9477932







## AMOR

### ROOSA NAUHA SYDÄN -IKKUNAKORISTE

Herkkä, helmikoristeltu sydän. Materiaali metalli ja muovi. Koristeena roosavärinen nauha. Sisältää paristot. Paristokotelo kapeassa metalliputkessa, jossa myös ripustuslenkki. LED lämmin valkoinen, ei vaihdettava. Johto kirkas. On/off-kytkin.

### ROSA BANDET FÖNSTERDEKORATION

Det sirliga hjärtat utsmyckat med pärlor. Material: metall och plast. Ett rosafärgat band som dekoration. Batterier medföljer. Batterifack i ett smalt metallrör som även har en ögla för upphängning. Varmvita LED-lampor, ej utbytbara. Genomskinlig sladd. Av/på-knapp.

### PINK RIBBON WINDOW HANGING

A delicate, pearl-decorated heart. Material: metal and plastic. Adorned with a pink ribbon. Batteries included. The battery casing is inside a metal tube that also has a loop for hanging. LED warm white, non-replaceable. Clear cord. On/off switch.

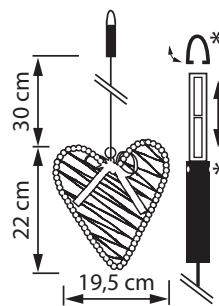

Nr 9478004





## HOPEAKURPITSA

### HALLOWEENKORISTE

Halloween tunnelmaan sopiva hopeanväriinen kurpitsa hehkuu kauniisti valoa. LED lämmin valkoinen, ei vaihdettava. Sisältää paristot. Materiaali muovi. On/off-kytkin.

### HALLOWEENPUMPA, SILVER

Silverfärgad pumpa som avger ett vackert ljusken och som passar bra till Halloween. Varmvita LED-lampor, ej utbytbara. Batterier medföljer. Material: plast. Av/på-knapp.

### HALLOWEEN PUMPKIN, SILVER

The silver-coloured Halloween-themed pumpkin provides beautiful glowing light. LED warm white, non-replaceable. Batteries included. Material: plastic. On/off switch.

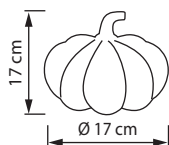

## HALLOWEEN KURPITSA

### PÖYTÄKORISTE

Halloween tunnelmaan iso LED-kurpitsa ärhökällä irvistyksellä. LED lämmin valkoinen, ei vaihdettava. Sisältää paristot. Materiaali muovi. On/off-kytkin.

### HALLOWEENPUMPA, ORANGE

Stor LED-pumpa med ett ilsket grin för äkta Halloweenstämning. Varmvita LED-lampor, ej utbytbara. Batterier medföljer. Material: plast. Av/på-knapp.

### HALLOWEEN PUMPKIN, ORANGE

Large Halloween-themed LED pumpkin with a feisty grin. LED warm white, non-replaceable. Batteries included. Material: plastic. On/off switch.





## KURPITSASARJA

### HALLOWEENVALOSARJA

Hauska koristesarja, jolla luot halloween tunnelmaa sekä sisällä että ulkona. LED valkoinen, ei vaihdettava. Sisältää paristot. Materiaali muovi. On/off-kytkin.

### PUMPSLINGA, HALLOWEENSLINGA

En rolig dekorationsslinga som ger halloweenstämning både inom- och utomhus. Vita LED-lampor, ej utbytbara. Batterier medföljer. Material: plast. Av/på-knapp.

### PUMPKIN SERIES, HALLOWEEN LIGHT SERIES

A nice ornamental series to create a Halloween atmosphere both in- and outdoors. LED white, non-replaceable. Batteries included. Material: plastic. On/off switch.

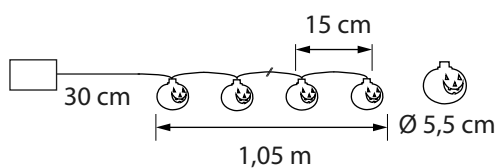

Nr 9478559



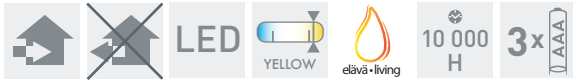

## KRUUNUKYNTTILÄT

### LED-KYNTTILÄT

Suomen itsenäisyyttä on perinteisesti juhlistettu asettamalla kaksi sinivalkoista kynttilää ikkunaan itsenäisyyspäivänä. LED-kynttilät ovat turvallinen tapa jatkaa tätä pitkää perinnettä. LED keltainen, eläväliekinen, ei vaihdettava. Sisältää paristot. Materiaali muovi. On/off-kytkin.

### LED-KRONLJUS

Enligt tradition har Finlands självständighet firats genom att placera två blåvita ljus i fönstret på självständighetsdagen. LED-ljusen är ett tryggt sätt att fortsätta denna långa tradition. Gula LED-lampor, flammande låga, ej utbytbara lampor. Batterier medföljer. Material: plast. Av/på-knapp.

### LED CANDLES

The Finnish Independence Day has traditionally been celebrated by placing two blue and white candles on the windowsill. LED candles are a safe way to continue this long tradition. LED yellow, "living flame", non-replaceable. Batteries included. Material: plastic. On/off switch.

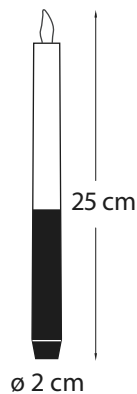

Nr 9477887





## SUOMI VALOLANKA

### LED-KORISTESARJA

Monipuolinen, kattaukseen ja koristeluun soveltuva valolanka. LED lämmin valkoinen, ei vaihdettava, rinnankytketty. Sisältää paristot. Materiaali taipuisa ja muotoiltava kuparilanka. Mukana irroitettavat sinivalkoiset nauhat. On/off-kytkin.

### LED-TRÅDSLINGA

Mångsidig ljusslinga som passar för dukningar och olika dekorationer. Varmvita LED-lampor, ej utbytbara, parallellkopplade. Batterier medföljer. Böjlig och formbar koppartråd. Blåvita, löstagbara band medföljer. Av/på-knapp.

### LED LIGHT WIRE

Versatile light wire suitable for table setting and decoration. LED warm white, non-replaceable, parallel connection. Batteries included. Material: pliable thin copper wire. Removable blue and white ribbons incl. On/off switch.

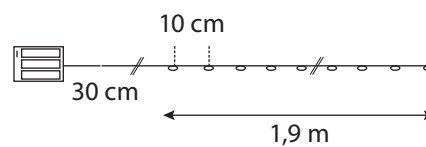

Nr 9477888





## LED-IKKUNASARJA

### IKKUNAKORISTE

Imukupilla kiinnitettävä kuuden kynttilän ikkunasarja. Imukupit irrallaan pakkauksessa. LED lämmin keltainen, vaihdettava, rinnankytketty. LED-varalampun nro 9477325. Johto kirkas.

### LED-FÖNSTERSLINGA

Dekorationsring för fönstret med 6 st. ljus och sugkoppar. Sugkopparna ligger separat i förpackningen. Varmgula LED-lampor, utbytbara, parallellkopplade. Reservlampans nr: 9477325. Genomskinlig sladd.

### LED WINDOW SET

A set of window lights with suction cups, 6 candles. The suction cups are included in the package separately. LED warm yellow, replaceable, parallel connection. Number of spare bulb (LED): 9477325. Clear cord.

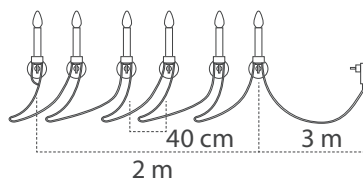

Nr 9476135





## DUO 100 IP44

### LED-SARJA

LED-sarja, jossa joka toinen LED on lämmin valkoinen/sininen. LED ei vaihdettava, kytketty 10 LEDin sarjaan. Johto tumma.

### LED-SLINGA

LED-slinga där varannan LED-lampa är varmvita/blå. LED ej utbytbara, kopplade i serie om tio lampor. Mörk sladd.

### LED CHAIN

An LED set, where every other LED is warm white/blue. LED non-replaceable, connected with 10 LEDs in a series. Dark cord.

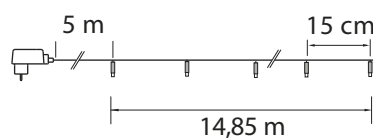

Nr 9477891





VALOLANGAT

Ljusslingor  
Light wires





#### LANGAT, JOTKA PYSYVÄT KÄSISSÄ.

Airamien valolangat taipuvat kaikkeen koristeluun. Kimaltelevan lankakerän, lankakorin tai vaikka hiuskoristeen tekeminen käy hetkessä. Osa valolangoista sopii myös ulkokäyttöön.

#### TRÅDAR SOM MAN HÅLLER I.

Airam's trådslingor kan användas till all dekoration. Det går snabbt att göra ett glittrande trådnystan, en trådback eller varför inte en hårdekoration. Några av trådslingorna kan även användas utomhus.

#### REINS THAT YOU HOLD.

Airam's light wires can be used for all kinds of decoration. It's easy to make a glittering ball of wires, a wire basket or a hair decoration. Some of our light wires can also be used outdoors.

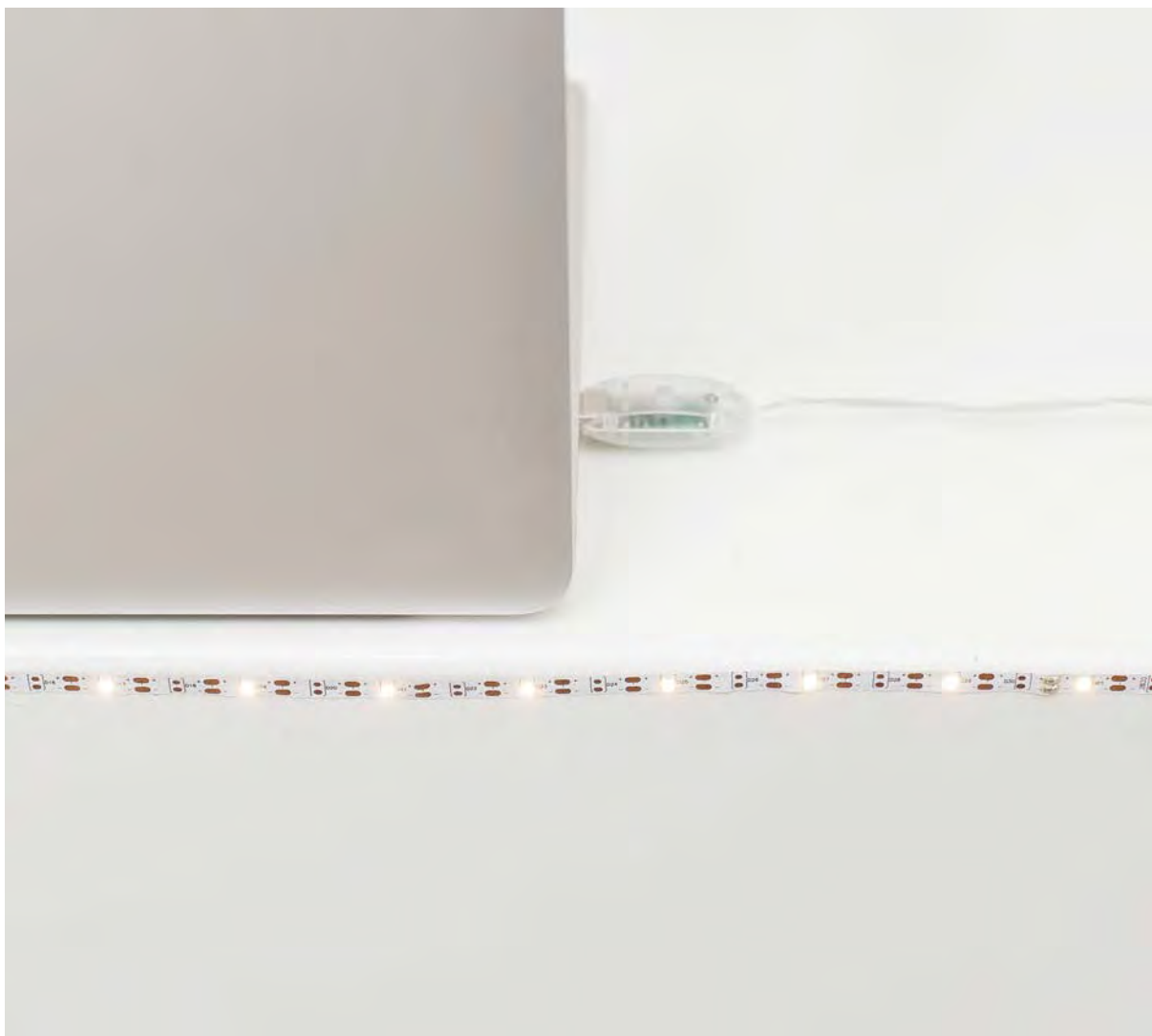

## POINT

### USB-VALONAUHA

Hauska, USB-liitännän kautta toimiva LED-nauha koristeluun ja tunnelmaa tuomaan. Tuote on tarkoitettu vain koristekäyttöön. Kaksi eri pituutta. LED lämmin valkoinen, ei vaihdettava. Materiaali metalli ja muovi.

### USB-LJUSBAND

Ett roligt LED-band att dekorera och skapa stämning med. Fungerar med USB så prova koppla med datorn eller TV'n. Får användas endast för dekoration. Två längder. LED varmvit, ej utbytbar. Tillverkad av metall och plast.

### USB LIGHT RIBBON

A nice USB powered LED ribbon for ornamentation and creating atmosphere. The product is intended for ornamentation only. Two different lengths. LED warm white, non-replaceable. Made of metal and plastic.

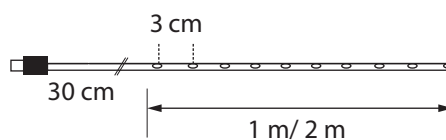

**NEW**

IP44

LED  
10WARM  
WHITE10 000  
H

6h TIMER

2xO  
CR2032

## MEA IP44

### VALOLANKA

Ulkokäyttöön soveltuva valolanka, jonka paristokotelo on suojattu vesiroiskeilta. Asettele esim. parvekkeella koristelyhtyjien sisälle. LED lämmin valkoinen, ei vaihdettava. Sisältää paristot ja ajastimen. Materiaali metalli ja muovi. On/off- ja ajastinkytkin.

### LJUSTRÅD

En ljustråd som lämpar sig för utomhusbruk. Batterifodralet är skyddat mot vattenstänk. Kan t.ex. placeras i dekorationslyktor på balkongen eller i blomkrukor. LED varmvit, ej utbyttbar. Innehåller batterier och en timer. Tillverkad av metall och plast. Av-/på- och timerknapp.

### LIGHT STRING

A light string suitable for outdoor use. The battery casing is protected against splashes. Can be placed e.g. in ornamental lanterns in the balcony. LED warm white, non-replaceable. Batteries and timer included. Made of metal and plastic. On/off and timer switch.

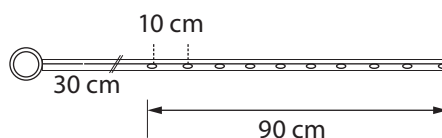

Nr 9478512



6 435200 246271



24



## ELLI

### PULLOVALO

Luo tyhjästä pulloista tai purnukoista kauniita valokoristeita. Paristot on piilotettu "korkin" sisälle. LED lämmin valkoinen tai värimix, ei vaihdettava. Sisältää paristot. Materiaali metalli, korkkiosa muovia. On/off-kytkin.

### FLASKLJUS

Skapa kreativa ljusdekorationer av tomma flaskor eller glasburkar. Batterierna är gömda i "korken". LED varmvit eller färgmix, ej utbyttbar. Batterier medföljer. Tillverkad av metall, korkdelen av plast. Av-/på-knapp.

### BOTTLE LIGHT

Create beautiful light ornaments of empty bottles or jars. The batteries lie hidden in the "cork". LED warm white or colour mix, non-replaceable. Made of metal, the cork part of plastic. On/off switch.

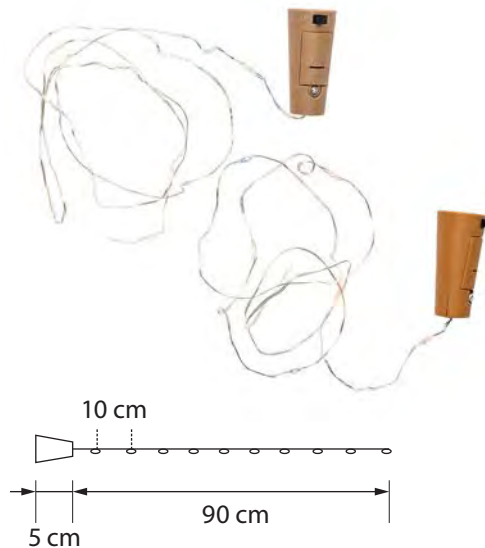

Nr 9478510





## NAPPI

### VALOLANKA

Kätevä valokoriste askarteluun, somisteisiin tai esim. kampauksiin! LED lämmin keltainen, ei vaihdettava, kytketty 10 LEDin sarjaan. Sisältää paristot. Materiaali ohut metallilanka, johon pienet LEDit on upotettu. On/off-kytkin.

### LED-TRÅDSLINGA

Behändig ljusdekoration för pyssel, som prydnad eller t.ex. i frisyre! Varmgula LED-lampor, ej utbytbara, kopplade i serie om tio lampor. Batterier medföljer. Material: tunn metalltråd med små infällda LED-lampor. Av/på-knapp.

### LED LIGHT WIRE

A handy light decoration for use in handicrafts, accessories or hairstyling, for example! LED warm yellow, non-replaceable, connected with 10 LEDs in a series. Batteries included. Made of thin metal wire into which the small LEDs are embedded. On/off switch.





## LED VALOLANKASARJA

### HOPEA

Kaunis hopeansävyinen valolanka monipuoliseen koristeluun. LED lämmin valkoinen, ei vaihdettava, rinnankytketty. Sisältää paristot. Materiaali ohut metallilanka, johon pienet LEDit on upotettu. On/off-kytkin.

### LED-TRÅDSLINGA, SILVER

Vacker dekorations slinga i silver för många olika ändamål. Varmvita LED-lampor, ej utbytbara, parallellkopplade. Batterier medföljer. Material: tunn metalltråd med små infällda LED-lampor. Av/på-knapp.

### LED LIGHT WIRE, SILVER

A beautiful silver-hued light wire for a wide variety of decorative purposes. LED warm white, non-replaceable, parallel connection. Batteries included. Made of thin metal wire into which the small LEDs are embedded. On/off switch.

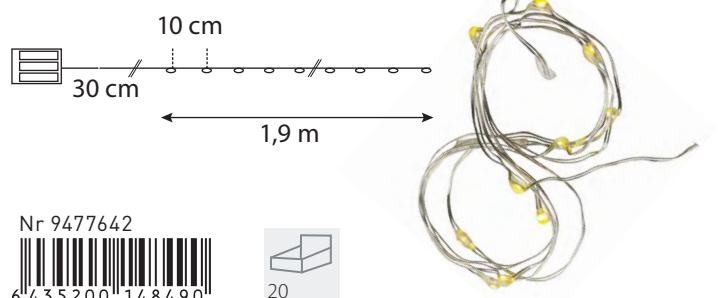

Nr 9477642





## LED VALOLANKASARJA

### KUPARI

Kaunis kuparinsävyinen valolanka monipuoliseen koristeluun. LED keltainen, ei vaihdettava, rinnankytketty. Sisältää paristot. Materiaali ohut metallilanka, johon pienet LEDit on upotettu. On/off-kytkin.

### LED-TRÅDSLINGA, KOPPAR

Vacker, kopparfärgad dekorations slinga för många olika ändamål. Gula LED-lampor, ej utbytbara, parallellkopplade. Batterier medföljer. Material: tunn metalltråd med små infällda LED-lampor. Av/på-knapp.

### LED LIGHT WIRE, COPPER

A beautiful copper-hued light wire for a wide variety of decorative purposes. LED yellow, non-replaceable, parallel connection. Batteries included. Made of thin metal wire into which the small LEDs are embedded. On/off switch.

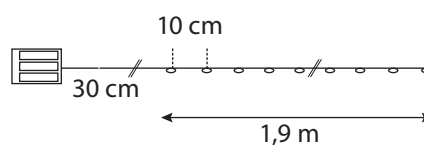

Nr 9476186





## ADELA

### KORISTESARJA

Pienet punaiset kuulapallot hiutalekuviolla. LED lämmin valkoinen, ei vaihdettava. Sisältää paristot. Materiaali muovi. Johto ohutta hopealankaa. On/off-kytkin.

### DEKORATIONSSLINGA

Små röda bollar med snöflingemönster. Varmvita LED-lampor, ej utbytbara. Batterier medföljer. Material: plast. Sladd av tunn silvertråd. Av/på-knapp.

### DECORATIVE LED LIGHT CHAIN

Small red spheres with a snowflake pattern. LED warm white, non-replaceable. Batteries included. Material: plastic. The cord consists of thin silver wire. On/off switch.

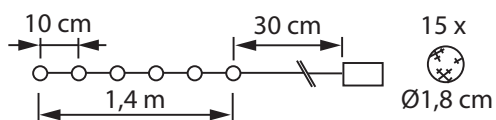

Punainen/ Röd/ Red

Nr 9478589







## ADELA

### KORISTESARJAT

Valikoimassa hopean tai kullan sävyiset pienet kuulapallot hiutalekuviolla. LED lämmin valkoinen, ei vaihdettava. Sisältää paristot. Materiaali muovi. Johto ohutta hopealankaa. On/off-kytkin.

### DEKORATIONSSLINGOR

Ljusslinga med silver- eller guldfärgade små bollar med snöflingemönster. Varmvita LED-lampor, ej utbytbara. Batterier medföljer. Material: plast. Sladd av tunn silvertråd. Av/på-knapp.

### DECORATIVE LED LIGHT CHAINS

The selection includes small silver or gold-coloured spheres with a snowflake pattern. LED warm white, non-replaceable. Batteries included. Material: plastic. The cord consists of thin silver wire. On/off switch.

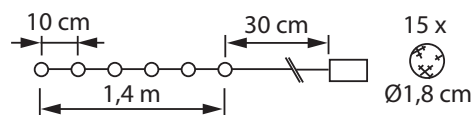

Hopea & kulta/  
Silver & Gold

Nr 9478025



6 435200 238658



18 (9/9)



## SAANA

### KORISTESARJAT

Valikoimassa kolme erilaista kuviosarjaa: kukka, kide- ja helmi-pallo. LED lämmin valkoinen, ei vaihdettava, rinnankytketty. Sisältää paristot. Materiaali muovi. Johto hopea metallilanka. On/off-kytkin.

### DEKORATIONSSLINGOR

I sortimentet finns tre olika mönster: blommor, kristall- och pärlbollar. Varmvita LED-lampor, ej utbytbara, parallellkopplade. Batterier medföljer. Material: plast. Sladd av silverfärgad metalltråd. Av/på-knapp

### DECORATIVE LED LIGHT CHAINS

The selection contains three different patterns: flower, crystal and pearl. LED warm white, non-replaceable, parallel connection. Batteries included. Material: plastic, the cord consists of silver-coloured metal wire. On/off switch.

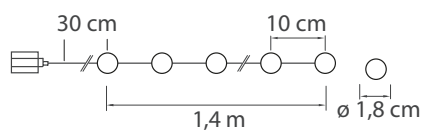
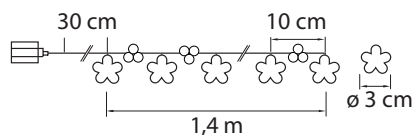
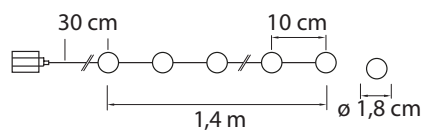

Nr 9477915





## SAANA

### KIDESARJA

Upea somiste kattauksiin ja koristeluun. Suosittu Saana kidepallo -koristesarja saatavissa myös omassa pöytäelineessään. LED lämmin valkoinen, ei vaihdettava, rinnankytketty. Sisältää paristot. Materiaali muovi. Johto hopea metallilanka. On/off-kytkin.

### LED-LJUSSLINGA MED KRISTALLER

Vacker dekoration för dukning och som prydnad. Den omtyckta dekorationsslingan Saana med kristallbollar finns även med ett eget bordsställ. Varmvita LED-lampor, ej utbytbara, parallellkopplade. Batterier medföljer. Material: plast. Sladd av silverfärgad metalltråd. Av/på-knapp.

### CRYSTAL BALL LED LIGHT CHAIN

A beautiful ornament for table setting and decoration. The popular Saana crystal ball decoration set is also available in a dedicated table rack. LED warm white, non-replaceable, parallel connection. Batteries included. Material: plastic, the cord consists of silver-coloured metal wire. On/off switch.

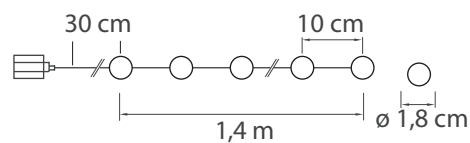

Nr 9477950





## HANS

### KORISTESARJA

Taivuteltava valolanka, jossa koristeena kymmenen sympaattista pientä norppaa. Savunharmaa sävy. LED lämmin valkoinen, ei vaihdettava. Sisältää paristot. Materiaali muovi. Johto hopea metallilanka. On/off-kytkin.

### DEKORATIONSSLINGA

En böjbar trådslinga dekorerad med tio små sympatiska vikare. Rökgrå ton. Varmvita LED-lampor, ej utbytbara. Batterier medföljer. Material: plast. Sladd av silvermetalltråd. Av/på-knapp.

### LIGHT CHAIN

A bendable light wire decorated with ten nice little ringed seals. Smoke grey shade. LED warm white, non-replaceable. Batteries included. Material: plastic. The cord consists of silver metal wire. On/off switch.

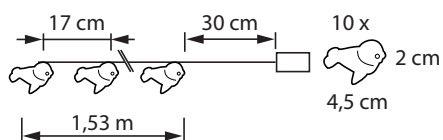

Nr 9478521





## UNICORN

### VALOLANKASARJA

Koristesarjassa kymmenen kirkasta yksisarvista (unicorn). Valolangan voi taivuttaa mielensä mukaan. LED lämmin valkoinen, ei vaihdettava. Sisältää paristot. Materiaali muovi. Johto hopea metallilanka. On/off-kytkin.

### TRÅDSLINGA

Dekorationsstringen har tio klara enhörningar (unicorn). Man kan böja trådslingan som man vill. Varmvita LED-lampor, ej utbytbara. Batterier medföljer. Material: plast. Sladd av silvermetalltråd. Av/på-knapp.

### LIGHT WIRE

The decorative light chain has ten clear unicorns. You can bend the light wire as you like it. LED warm white, non-replaceable. Batteries included. Material: plastic. The cord consists of silver metal wire. On/off switch.

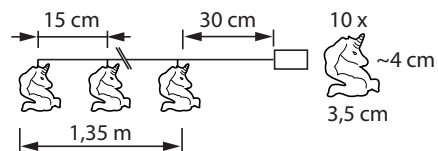

Nr 9478522



**NEW**

IP20

LED  
8010 000  
H

DC 4,5V 1,35W

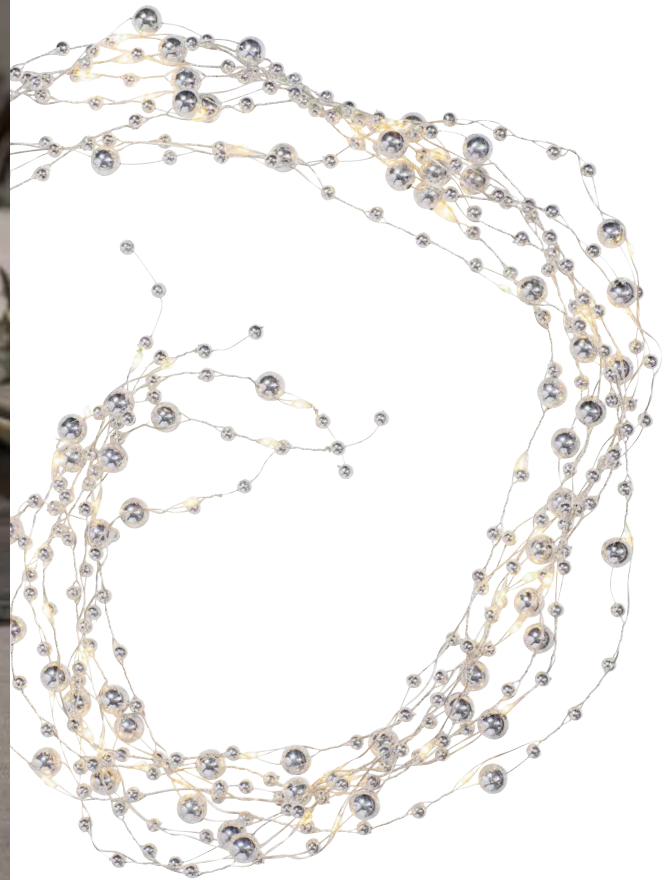

## RONJA

### HOPEAHELMISARJA

Pienillä hopeahelmillä koristeltu tyylikäs koristesarja, jossa on kahdeksan koristeltua valolankaa. Jokaisen langan voi erikseen taivuttaa haluttuun muotoon. LED lämmin valkoinen, ei vaihdettava. Materiaali metalli ja muovi. Johto kirkas.

### SILVERPÄRLSLINGA

En elegant dekorationsslinga med små silverpärlor och åtta dekorerade trådslingor. Man kan böja varje slinga i vilken form man vill. Varmvita LED-lampor, ej utbytbara. Material: metall och plast. Genomskinlig sladd.

### SILVER PEARL CHAIN

An elegant light chain decorated with small silver pearls and eight light wires. You can bend each wire into any shape. LED warm white, non-replaceable. Materials: metal and plastic. Clear cord.

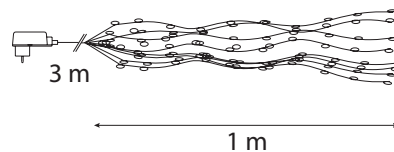

Nr 9478562



6 435200 246394



12



## LED VALOLANKARYHMÄ IP44

### HOPEA

Hopeanvärinen valolankaryhmä, taivuteltavissa eri muotoon. LED lämmin keltainen (ketjut: 5 x 20 LED, 10 x 10 LED), ei vaihdettava, kytketty 10 LEDin sarjaan. Materiaali ohut metallilanka. Johto kirkas.

### GRUPP AV LED-TRÅDSLINGOR, SILVER

Grupp av silverfärgade LED-dekorations slingor som kan formas. Varmgula LED-lampor (slingor: 5 x 20 lampor, 10 x 10 lampor), ej utbytbara, kopplade i serie om tio lampor. Material: tunn metalltråd. Genomskinlig sladd.

### LED LIGHT WIRE SET, SILVER

A silver-coloured light wire set that can be arranged into different shapes. LED warm yellow (chains: 5 x 20 LEDs, 10 x 10 LEDs), non-replaceable, connected with 10 LEDs in a series. Made of thin metal wire into which the small LEDs are embedded. Clear cord.

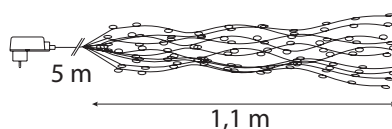
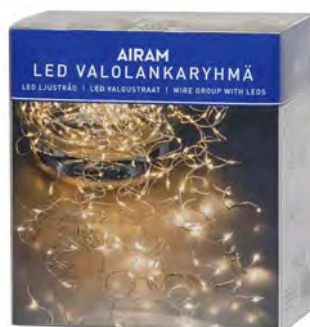

Nr 9477028



IP44

WARM  
YELLOW10 000  
H

## LED VALOLANKARYHMÄT IP44

### KUPARI

Kuparinvärinen valolankaryhmä, taivuteltavissa eri muotoon. Kaksi eri pituutta. LED lämmin keltainen, ei vaihdettava. Materiaali ohut metallilanka. Johto kirkas.

### GRUPP AV LED-TRÅDSLINGOR, KOPPAR

Grupp av kopparfärgade LED-dekorations slingor som kan formas. Tillgänglig i två olika längder. Varmgula LED-lampor, ej utbytbara. Material: tunn metalltråd. Genomsiktig sladd.

### LED LIGHT WIRE SETS, COPPER

A copper-coloured light wire set that can be arranged into different shapes. Two different lengths. LED warm yellow, non-replaceable. Made of thin metal wire into which the small LEDs are embedded. Clear cord.



**LED  
100** DC 4,5V 1,35W

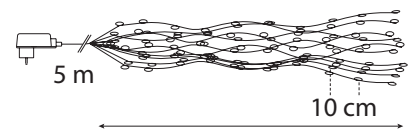

**LED  
360** DC 4,5V 4,5W

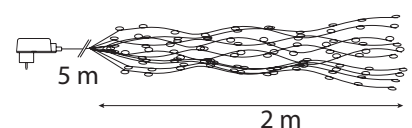





## NIILI IP44

### KIERRESARJA

Hopeanvärinen tai musta valosarja, joka taipuu helposti haluttuun muotoon. Kaunis esim. kuistilla pihalyhdyn sisällä. LED lämmin valkoinen, ei vaihdettava, rinnankytketty. Materiaali metalli. Johto kierretty hopea tai musta.

### SPIRALSLINGA

LED-dekorations slinga i silver eller svart som enkelt kan formas. Vacker dekoration för t.ex. lyktan på verandan. Varmvita LED-lampor, ej utbytbara, parallellkopplade. Material: metall. Tvinnad sladd i silver eller svart.

### SPIRAL CORD SET

A silver or black light set of lights that can be easily arranged into the desired shape. A beautiful decoration for the porch or inside a yard lantern, for example. LED warm white, non-replaceable, parallel connection. Made of metal. The wire is either twisted black or silver.

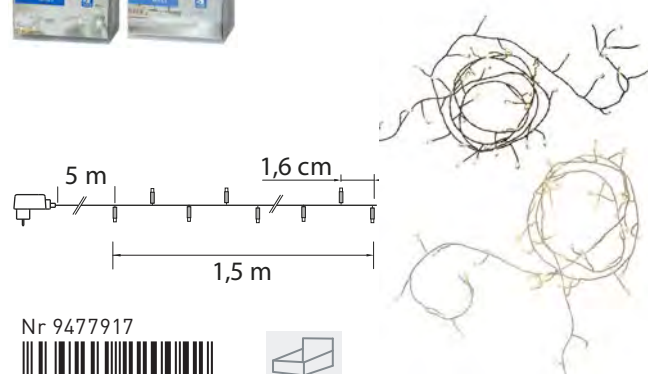

Nr 9477917



6 435200 220042





KORISTEVALOT SISUSTUKSEEN  
JA KATTAUKSEEN

Dekorationsbelysning för inredning och dukningar  
Lights for Interior and Table Setting





#### TÄDELLINEN TUNNELMA SYNTYY PIENISTÄ YKSITYISKOHDISTA.

Tee arjesta kauniimpaa tai luo juhlapyyhiin arvoistansa tunnelmaa. Valosarjoilla on helppo koristaa kattauksia ja korostaa kodin sisustuksen yksityiskohtia. Uudet valotaulut puolestaan valaisevat sisustajansa persoonallisuutta. Kirjoita, mitä haluat kertoa.

#### EN PERFEKT STÄMNING BESTÅR AV SMÅ DETALJER.

Gör vardagen vackrare eller skapa en stämning som motsvarar högtiden. Med ljusslingor är det lätt att dekorera dukade bord och framhäva detaljer i inredningen. Nya ljusstavlor belyser inredarens personlighet. Skriv vad du vill berätta.

#### A PERFECT ATMOSPHERE CONSISTS OF SMALL DETAILS.

Make your days more beautiful or create an atmosphere worthy of the celebration. With light chains, it's easy to decorate tables and highlight details in your interior design. New illuminated boards shed light on the personality of the one who made the design. Write what you'd like to say.



## NUOLI

### SEINÄKORISTE

Hauska nuolimainen koristevalo osoittaa sisustuksen uuden suunnan. Nuolen voi asettaa helposti haluamaansa paikkaan. LED lämmin valkoinen, ei vaihdettava. Sisältää paristot. Materiaali metalli. Johto kirkas. On/off-kytkin.

### PIL - VÄGGDEKORATION

Ett roligt dekorationsljus - en pil som visar inredningens nya riktning. Det är lätt att placera pilen var man vill. Varmvita LED-lampor, ej utbytbara. Batterier medföljer. Material: metall. Genomskinlig sladd. Av/på-knapp.

### ARROW - WALL HANGING

A nice decorative light set - an arrow pointing at the new direction of interior design. You can easily place the arrow wherever you want to. LED warm white, non-replaceable. Batteries included. Material: metal. Clear cord. On/off switch.

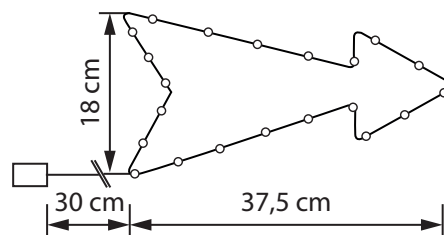

Nr 9478524





## &-MERKKI

### SEINÄKORISTE

Uutta ilmettä sisustukseen. Hauskalla &-merkillä luot kivoja sisustuskokonaisuuksia. LED lämmin valkoinen, ei vaihdettava. Sisältää paristot. Materiaali metalli. Johto kirkas. On/off-kytkin.

### &-VÄGGDEKORATION

Ett nytt inslag i inredningen. Med det roliga &-tecknet kan du skapa skojiga helheter i inredningen. Varmvita LED-lampor, ej utbytbara. Batterier medföljer. Material: metall. Genomskinlig sladd. Av/på-knapp.

### AMPERSAND WALL HANGING

Adds new expression to interior design. With the nice &-sign, you can create intriguing decorations. LED warm white, non-replaceable. Batteries included. Material: metal. Clear cord. On/off switch.

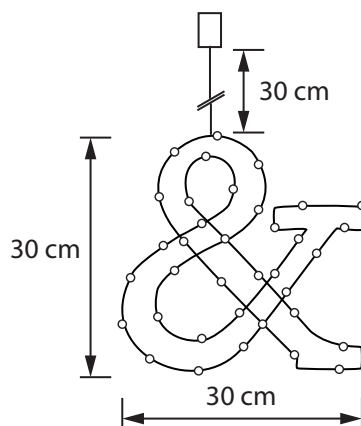

Nr 9478525





## PILVI

### SEINÄKORISTE

Uutta ilmettä sisustukseen kevyellä, helposti seinälle asetettavalla pilvenhattaralla. LED lämmin valkoinen, ei vaihdettava. Sisältää paristot. Materiaali metalli. Johto kirkas. On/off-kytkin.

### VÄGGDEKORATION

Förnya inredningen med en liten molntapp som är lätt att montera på väggen. Varmvita LED-lampor, ej utbytbara. Batterier medföljer. Material: metall. Genomskinlig sladd. Av/på-knapp.

### WALL HANGING

Create a new decorative look with a cloud-shaped accessory that is easy to hang on a wall. LED warm white, non-replaceable, Batteries included. Material: metal, Clear cord. On/off switch.

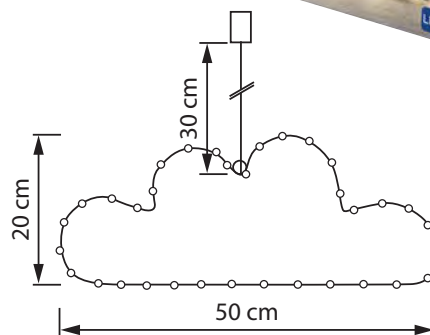

Nr 9478027





# LOVE

## SEINÄKORISTE

Uutta ilmettä sisustukseen kevyellä, helposti seinälle asetettavalla Love-koristetekstillä. LED lämmin valkoinen, ei vaihdettava. Sisältää paristot. Materiaali metalli. Johto kirkas. On/off-kytkin.

## VÄGGDEKORATION

Förnya inredningen med en sirlig väggdekoration med texten "love" som är lätt att montera på väggen. Varmvita LED-lampor, ej utbytbara. Batterier medföljer. Material: metall. Genomskinlig sladd. Av/på-knapp.

## WALL HANGING

Create a new decorative look with an accessory spelling "love" that is easy to hang on a wall. LED warm white, non-replaceable, Batteries included. Material: metal, Clear cord. On/off switch.

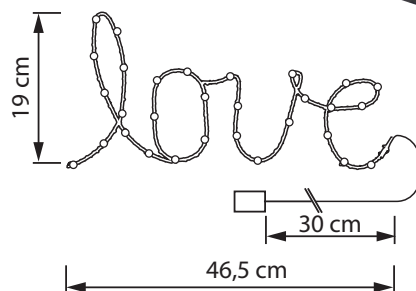

Nr 9478028





## DATA

### KIRJAIN- JA NUMEROTAULU

Kirjoita viestisi valaistuun tauluun. Taulun mukana tulee 60 kirjainta ja numeroa sekä muutamia erikoismerkkejä. LED lämmin valkoinen, ei vaihdettava. Sisältää paristot. Materiaali muovi. On/off-kytkin.

### BOOKSTAVS- OCH SIFFERTAVLA

Skriv en hälsning på den upplysta tavlan. 60 bokstäver och siffror samt några specialtecken följer med tavlan. Varmvita LED-lampor, ej utbytbara. Batterier medföljer. Material: plast. Av/på-knapp.

### LETTER AND NUMERAL BOARD

Write your message on the illuminated board. The board comes with 60 letters and numerals as well as a few special characters. LED warm white, non-replaceable. Batteries included. Material: plastic. On/off switch.

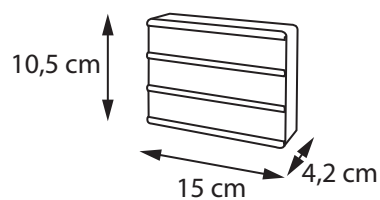

Nr 9478569





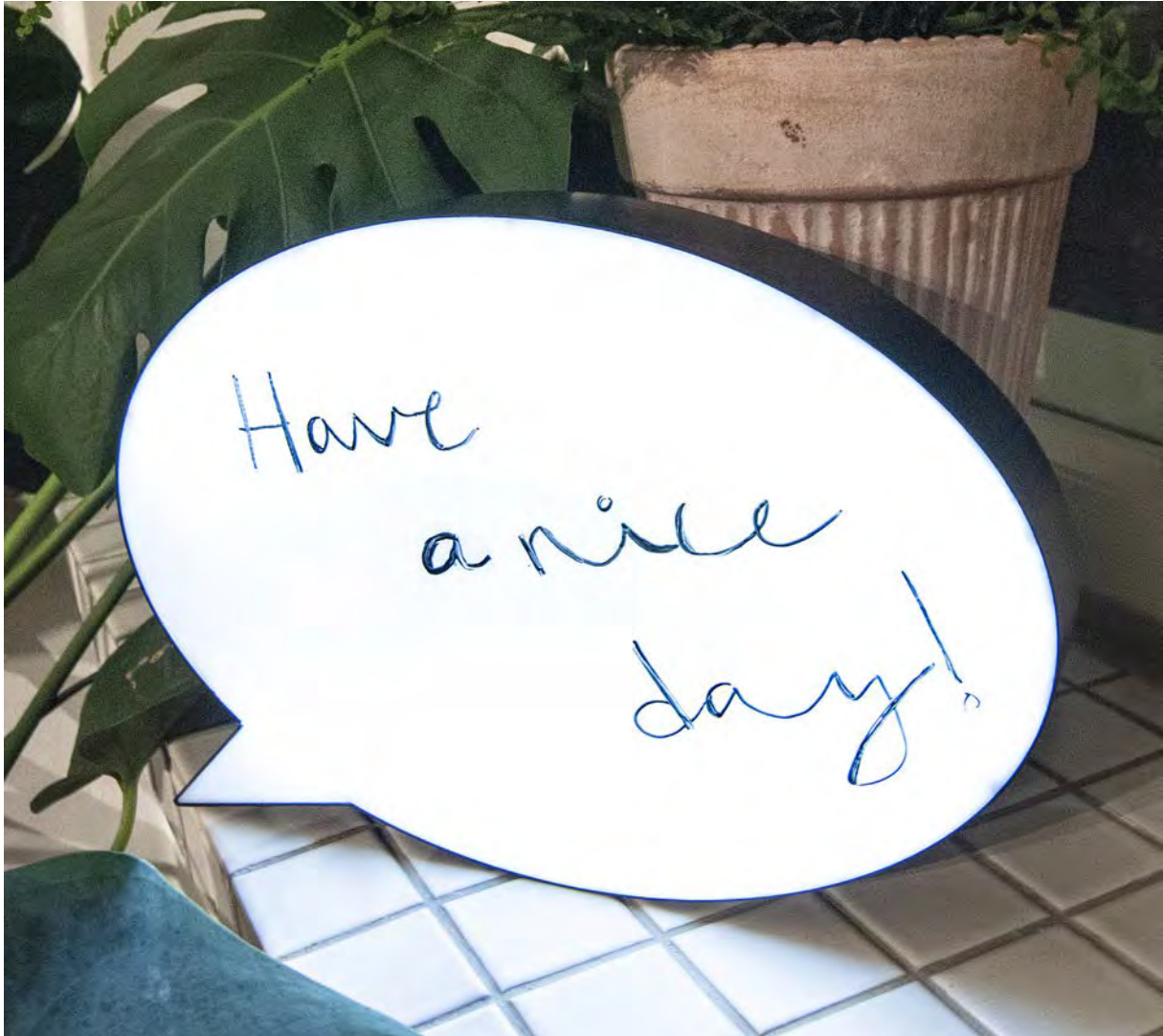

## DATA

### KIRJOITUSTAULU JA KYNÄ

Valaise asiasi puhekuplassa. Taulun mukana tulee kynä, jonka korkki toimii pyyhekumina. Kupla seisoo tukevasti itsekseen. LED lämmin valkoinen, ei vaihdettava. Sisältää paristot. Materiaali muovi. On/off-kytkin.

### SKRIVTAVLA OCH PENNA

Skriv upplysningar i pratbubblan. Med tavlan följer en penna med en kapsyl som kan radera. Pratbubblan står stadigt. Varmvita LED-lampor, ej utbytbara. Batterier medföljer. Material: plast. Av/på-knapp.

### WRITING BOARD WITH PEN

Write your message in the balloon. The board comes with a pen with an erasing end. The balloon stands up by itself. LED warm white, non-replaceable. Batteries included. Material: plastic. On/off switch.

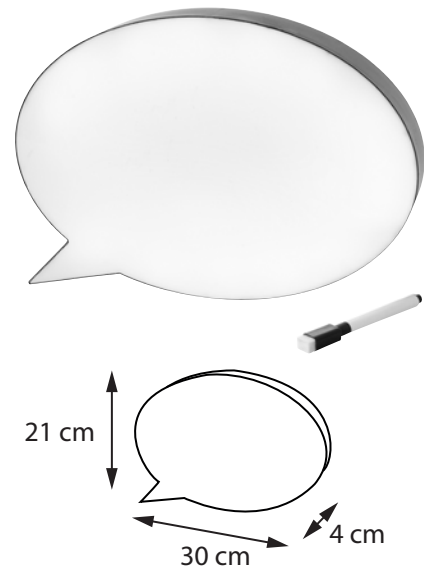

Nr 9478528



**NEW**

IP20

LED  
2010 000  
HDC 31V 3,6W  

## FRIDA

### KÖYNNÖS

Kimaltava shampanjan sävyisin lehdin ja helmin koristeltu upea köynnös kattauksiin tai valokoristeeksi lipaston päälle. LED lämmin valkoinen, ei vaihdettava. Materiaali muovi. Johto kirkas.

### GIRLANG

En fin glittrande girland dekorerad med champagnetonade löv och pärlor - för dukningar eller som ljusdekoration på en byrå. Varmvita LED-lampor, ej utbytbara. Material: plast. Genomskinlig sladd.

### FESTOON

Decorated with champagne coloured leaves and pearls, an impressive, glittering festoon for table setting or as a light decoration on a chest of drawers. LED warm white, non-replaceable. Material: plastic. Clear cord.

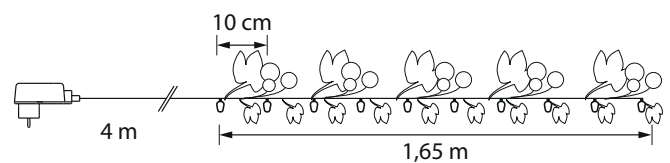

Nr 9478529



6 435200 246790



6



## SAIMI

### KÖYNNÖS

Perinteisin joulukukin, kävyin ja lehdin koristeltu upea köynnös pöytäkoristeeksi. LED lämmin valkoinen, ei vaihdettava. Materiaali muovi. Johto kirkas.

### GIRLANG

En stilig girlang dekorerad med traditionella julblommor, kottar och löv - som bordsdekoration. Varmvita LED-lampor, ej utbytbara. Material: plast. Genomsiktig sladd.

### FESTOON

A beautiful festoon decorated with traditional Christmas flowers, cones and leaves - a table decoration. LED warm white, non-replaceable. Material: plastic. Clear cord.

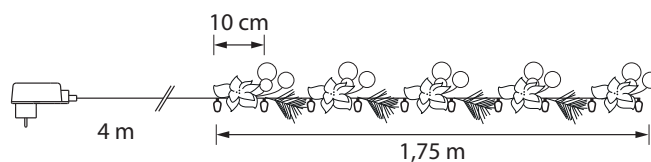

Nr 9478530





## LED HAVUKÖYNNÖS 40 IP44

### HAAROITTUVAT OKSAT

Havuköynnös haaroittuvilla oksilla ja aidon oloisilla havuilla. LED lämmin valkoinen, ei vaihdettava, kytketty 10 LEDin sarjaan. Materiaali muovi. Johto musta.

### LED-GIRLANG

Girlang med verklighetstrogn grankvistar som förgrenar sig. Varmvita LED-lampor, ej utbytbara, kopplade i serie om tio lampor. Material: plast. Svart sladd.

### LED FIR TWIG VINE

A fir twig garland with branches and genuine-looking needles. LED warm white, non-replaceable, connected with 10 LEDs in a series. Material: plastic. Black cord.

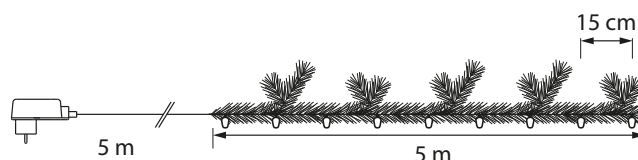

Nr 9477845





## LED HAVUKÖYNNÖS 50 IP44

### TUUHEA

Helposti muotoiltava, tuuhea ja pehmeä havuköynnös. LED lämmin valkoinen, ei vaihdettava, kytketty 5 LEDin sarjaan. Materiaali muovi. Johto musta.

### LED-GIRLANG

Tät och mjuk grangirang som är lätt att forma. Varmvita LED-lampor, ej utbytbara, kopplade i serie om fem lampor. Material: plast. Svart sladd.

### LED FIR TWIG VINE

Easily shapeable, lush and soft fir twig garland. LED warm white, non-replaceable, connected with 5 LEDs in a series. Material: plastic. Black cord.

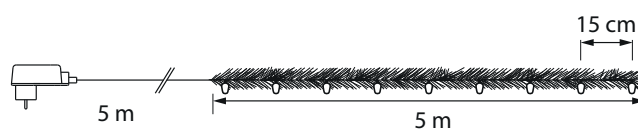

Nr 9476713





## HAVU 30 CM

### PÖYTÄKUUSI

Koristele oman maun ja tyylin mukaan lisäämällä rusetteja, karkkeja, kristalleja jne. LED lämmin valkoinen, ei vaihdettava, kytketty 5 LEDin sarjaan. Sisältää paristot. Materiaali muovi. Ruukun suojana säkkikangas, havuissa käpyjä. On/off-kytkin.

### BORDSGRAN

Dekorera som du vill med rosetter, godis, kristaller m.m. Varmvita LED-lampor, ej utbytbara, kopplade i serie om fem lampor. Batterier medföljer. Material: plast. Krukan täckt av säckväv, kvistarna har kottar. Av/på-knapp.

### SPRUCE

Decorate to your own taste and style by adding bows, candies, crystals, etc. LED warm white, non-replaceable, connected with 6 LEDs in a series. Batteries included. The pot is protected by sack cloth and the spruce twigs are adorned by cones. On/off switch.

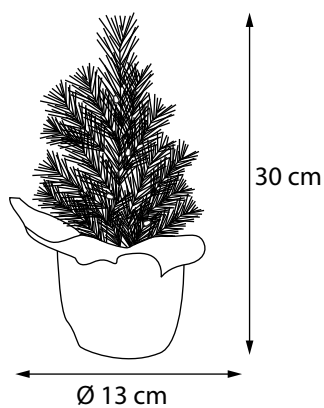

Nr 9477919



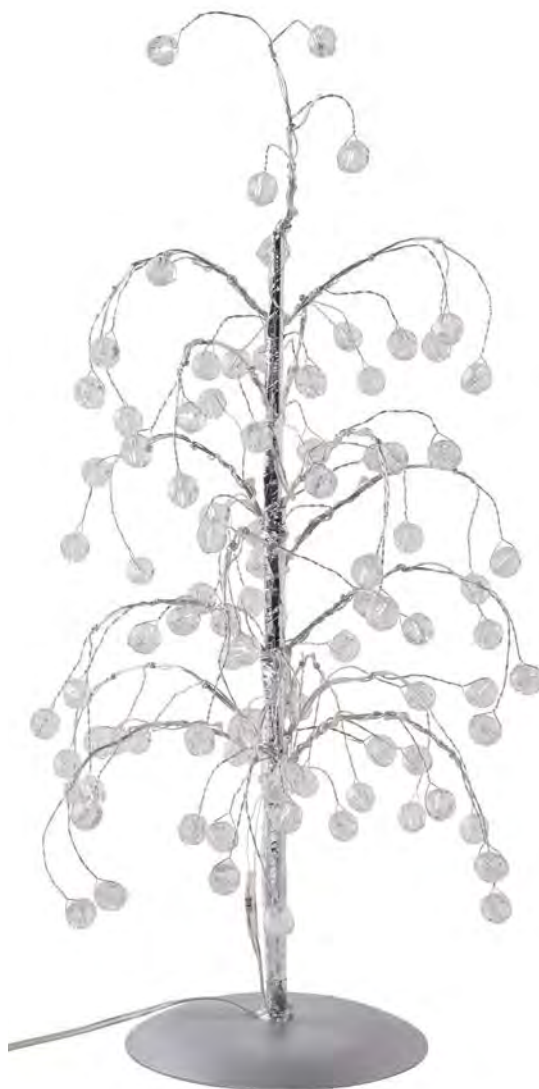

## OULA

### PÖYTÄKORISTE

Kaunis puu kidekoristeilla. Asettele oksat haluamallasi tavalla. LED lämmin valkoinen, ei vaihdettava, rinnankytketty. Materiaali muovi ja metalli. Johto kirkas.

### BORD DEKORATION

Vackert träd utsmyckat med kristaller. Ordna grenarna som du vill. Varmvita LED-lampor, ej utbytbara, parallellkopplade. Material: plast och metall. Genomsiktig sladd.

### TABLE DECORATION

A beautiful tree with crystal ornaments. Arrange the branches as you desire. LED warm white, non-replaceable, parallel connection. Material: metal and plastic. Clear cord.

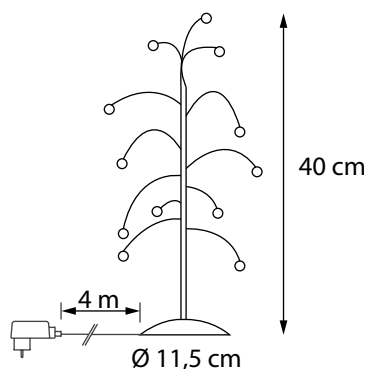



## BOX

### KORISTEPAKETIT

Valikoima erivärisiä lahjapaketteja kimallerusetein. Rusetin sävyt hopea, punainen, vihreä ja sininen. LED lämmin valkoinen, ei vaihdettava. Materiaali muovi.

### DEKORATIONSPAKET

Ett urval av presentförpackningar med gnistrande rosetter i olika färger. Rosetten finns i silver, rött, grönt och blått. Varmvita LED-lampor, ej utbytbara. Material: plast.

### DECORATIVE GIFT PACKAGES

A selection of gift packages in different colours with glittering bows. The bows come in hues of silver, red, green and blue. LED warm white, non-replaceable. Material: plastic.

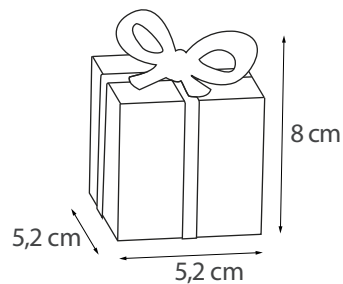

Nr 9477939







## TRIO

### LAHJAPAKETIT

Kolme kimallelangalla koristeltua lahjapakettia. Packageissa puna-valkoiset rusettinauhat, jotka voi halutessaan itse vaihtaa muunlaisiin. LED 3 kpl: 1 kpl/ paketti, lämmin valkoinen, ei vaihdettava. Sisältää paristot. Materiaali muovi ja metalli. Johto kirkas. On/off-kytkin.

### PRESENTFÖRPACKNINGAR

Tre presentförpackningar dekorerade med glittertråd. Förpackningarna har röd-vita rosettbänd som man själv kan välja att byta ut mot andra bänd. LED 3 st: en LED per förpackning, varmvita, ej utbytbara. Batterier medföljer. Material: plast och metall. Genomskinlig sladd. Av/på-knapp.

### GIFT PACKAGES

Three gift packages decorated with glitter thread. The packages have red-white bow ribbons that may be used as an option. LED 3 pcs: one per package, warm white, non-replaceable. Batteries included. Materials: plastic and metal. Clear cord. On/off switch.

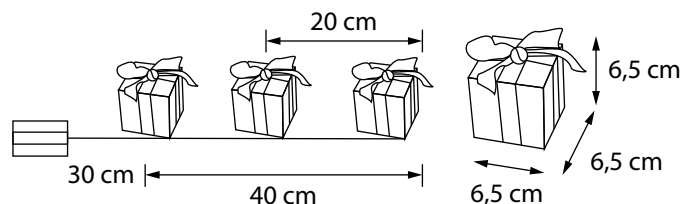

Nr 9478531



NEW



LED  
5



10 000  
H



2x  
CR2032



## MARY

### ENKELIKORISTE

Kaunis pitsimekkoinen enkelikoriste. Ripusta koriste roikkumaan kuuseen, ikkunaan tai koristeeksi kranssiin. LED lämmin valkoinen, ei vaihdettava. Sisältää paristot. Materiaali muovi ja kangas. On/off-kytkin.

### ÄNGEL

En vacker dekorativ ängel i spetskläddning. Kan hängas upp i julgranen, i ett fönster eller som dekoration på en krans. Varmvita LED-lampor, ej utbytbara. Batterier medföljer. Material: plast och tyg. Av/på-knapp.

### ANGEL

A beautiful decorative angel in a lace gown. Hang it on your Christmas tree, in a window or on a wreath. LED warm white, non-replaceable. Batteries included. Materials: plastic and fabric. On/off switch.

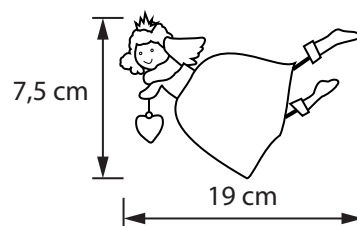

Nr 9478553





## FANTASIA

### KORISTEOVI

Pieni koristeovi, jonka voi stailata haluamallaan tavalla, esimerkiksi koristelemalla se kransilla tai havuköynnöksellä. Ovi aukeaa yhteen suuntaan. Kurkkiiko tonttu oven raosta? LED lämmin valkoinen, ei vaihdettava. Sisältää paristot. Materiaali puu. On/off-kytkin.

### DEKORATIONSÖRR

En liten dekorationsdörr som man kan stajla eller dekorera som man vill, t.ex. med en krans eller en granisgirland. Dörren öppnar sig i en riktning. Är det tomten som kikar genom dörrspringan? Varmvita LED-lampor, ej utbytbara. Batterier medföljer. Material: trä. Av/på-knapp.

### DECORATIVE DOOR

A small decorative door that can be styled or decorated as desired, e.g. with a wreath or a festoon of fir. The door swings one way. Is that a pixie peeping through the crack in the door? LED warm white, non-replaceable. Batteries included. Material: wood. On/off switch.

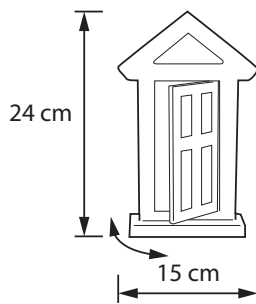

Nr 9478527





## 2 IN 1

### KORISTETÄHTI

Monipuolinen ja näyttävä pöytäkoriste, jossa sisempi tähti voidaan irrottaa isommasta. Yhden tähden sijaan saat kaksi eri kokoista, yhteensopivaa koristetta. LED 10 kpl/ iso tähti ja 5 kpl/ pieni tähti, lämmin valkoinen, ei vaihdettava. Sisältää paristot. Materiaali puu. On/off-kytkin erikseen molemmissa tähdissä.

### DEKORATIONSSTJÄRNA

En mångsidig och imponerande bordsdekoration. De två stjärnorna kan tas isär. I stället för en stjärna får du en mindre och en större dekoration som passar in i varandra. Den stora har tio och den lilla har fem varmvita LED-lampor, ej utbytbara. Batterier medföljer. Material: trä. Stjärnorna har var sin av/på-knapp.

### DECORATIVE STAR

A versatile and impressive table decoration. The two stars can be separated. Instead of one star, you get a large star with a small star inside. The large star has ten and the small star has five warm white LEDs, non-replaceable. Batteries included. Material: wood. Each star has its own on/off switch.

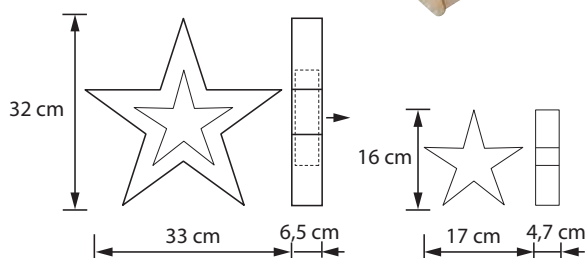

Nr 9478532





## PETRA

### LED-TÄHTI

Mosaikkikuvioitu tähti, josta valo kajastaa kauniisti. LED lämmin valkoinen, ei vaihdettava. Sisältää paristot. Materiaali muovi, kimaltava sisäosa. On/off-kytkin.

### LED-STJÄRNA

Stjärna med mosaikmönster som avger ett vackert sken. Varmvita LED-lampor, ej utbytbara. Batterier medföljer. Material: plast, glittrande inre del. Av/på-knapp.

### LED STAR

A mosaic-patterned star providing beautiful shimmering light. LED warm white, non-replaceable. Batteries included. Material: plastic, shiny interior. On/off switch.

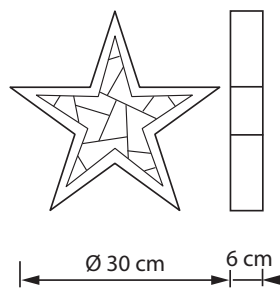

Nr 9478002





## BERIT

### PÖYTÄKORISTE

Itsenäisesti seisova tähtikoriste. Tähteen pujotettu valolanka kajastaa kauniisti valoa. LED lämmin valkoinen, ei vaihdettava LED, rinnankytketty. Materiaali metalli. Johto kirkas.

### BORDSDEKORATION

Stående stjärndekoration. Ljusslingan som har lindats kring stjärnan avger ett vackert ljusskimmer. 80 st. varmvita LED-lampor, ej utbytbara, parallellkopplade. Material: metall. Genomskinlig sladd.

### TABLE DECORATION

A free-standing star ornament. The string of lights threaded around a star provides a beautiful shimmering light. LED warm white, non-replaceable, parallel connection. Material: metal. Clear cord.

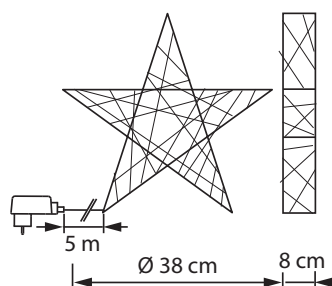

Nr 9478013



**NEW**

IP20

LED  
4010 000  
H

DC 4,5V 0,4W



## TELLUS

### METALLIPALLO

Näyttävä valokoriste. Liitä puoliskoja yhdistävä johto ja kiinnitä puolipallot toisiinsa mukana olevilla nippusiteillä. Luo useamman pallon upeita kokonaisuuksia. Palloa valaisee led-sarja. LED lämmin valkoinen, ei vaihdettava. Materiaali metalli. Johto kirkas.

### METALLKULA

En imponerande ljusdekoration. Koppla in sladden som förenar halvorna och sätt ihop dem med medföljande buntband. Du kan skapa fina helheter av flera kular. Kulan belyses av en LED-slinga. Varmvita LED-lampor, ej utbytbara. Material: metall. Genomsiktig sladd.

### METAL BALL

An impressive light decoration. Plug in the cord connecting the halves. Join the halves with the plastic ties included. You can make combinations of several balls. The ball is illuminated by a set of LEDs. LED warm white, non-replaceable. Material: metal. Clear cord.

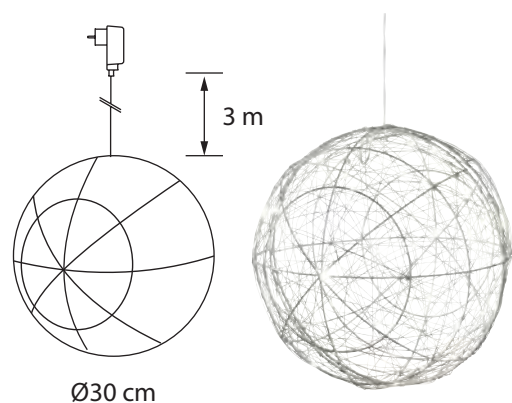

Nr 9478552



6



## ANANAS

### LED-KORISTEVALOSARJA

Sarja hopeanvärisiä ananaksia piristää kattausta. Antaa verkko-maisen valon. LED lämmin valkoinen, ei vaihdettava. Sisältää paristot. Materiaali metalli. Johto kirkas. On/off-kytkin.

### LED-DEKORATIONSSLINGA

En ljusslinga med silverfärgade ananaslampor piggar upp dukningen. Avger ett nätmönstrat sken. Varmvita LED-lampor, ej utbytbara. Batterier medföljer. Material: metall. Genomskinlig sladd. Av/på-knapp.

### DECORATIVE LED SET

A set of silver-coloured pineapples to brighten up any table setting. Provides a netlike light. LED warm white, non-replaceable. Batteries included. Material: metal. Clear cord. On/off switch.

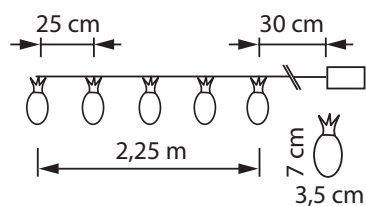

Nr 9478026







## ELLA

### KIMALLESARJA

Kimallekoristeltu kukka/helmisarja monipuoliseen koristeluun. Voidaan taivutella eri muotoon. Sisältää paristot. Paristokotelo kapeassa metalliputkessa, jossa myös ripustuslenkki. LED lämmin valkoinen, ei vaihdettava. Johto kirkas. On/off-kytkin.

### GLITTERSLINGA

Blom-/pärlslinga utsmyckad med glitter för många olika ändamål. Kan böjas i olika former. Batterier medföljer. Batterifacket finns i ett smalt metallrör, som även har en ögla för upphängning. Genomskinlig sladd. Av/på-knapp.

### GLITTER SET

A glitter-adorned flower/pearl set for versatile decoration. Can be arranged into different shapes. Batteries included. Battery casing inside a narrow metal tube that also includes a loop for hanging. LED warm white, non-replaceable. Clear cord. On/off switch.



Nr 9478034





## KATJA

### LED-SARJA

Hopealehtikoristeet sekä kirkkaita kukkakoristeita. LED lämmin keltainen, ei vaihdettava, kytketty 10 LEDin sarjaan. Johto kirkas.

### LED-SLINGA

Silverfärgade lövdekorationer och genomskinliga blomdekorationer. Varmgula LED-lampor, ej utbytbara, kopplade i serie om tio lampor. Genomskinlig sladd.

### LED LIGHT CHAIN

Silver leaf decorations and bright flower ornaments. LED warm yellow, non-replaceable, connected with 10 LEDs in a series. Clear cord.

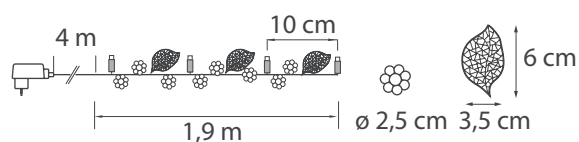

Nr 9476197





## HOPEAKÄPY IP44

### LED-SARJA

Ulosijoitettavalla vesisuojatulla paristokotelolla ja ajastimella varustettu koristasarja katettuun ulkotilaan. LED lämmin valkoinen, ei vaihdettava, kytketty 10 LEDin sarjaan. Materiaali muovi. Johto kirkas.

### LED-SLINGA

Dekorations slinga med vattentätt batterifack och timer för utomhusutrymmen med tak. Varmvita LED-lampor, ej utbytbara, kopplade i serie om tio lampor. Material: plast. Genomskinlig sladd.

### LED LIGHT CHAIN

A decorative set with a water-proof outdoor battery case and timer for use in covered outdoor spaces. LED warm white, non-replaceable, connected with 10 LEDs in a series. Material: plastic. Clear cord.

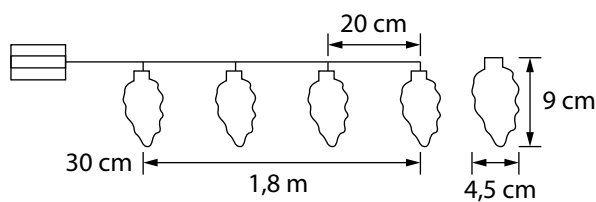

Nr 9477947





## EVELYN

### TÄHTISARJA

Koristesarja, jossa kauniit kuparinsävyiset tähdet. LED lämmin valkoinen, ei vaihdettava. Sisältää paristot. Johto kirkas.

### STJÄRNSLINGA

En dekorationslinga med vackra koppartonade stjärnor. Varmvita LED-lampor, ej utbytbara. Batterier medföljer. Genomskinlig sladd.

### STAR SET

A decorative set with beautiful copper coloured stars. LED warm white, non-replaceable. Batteries included. Clear cord.

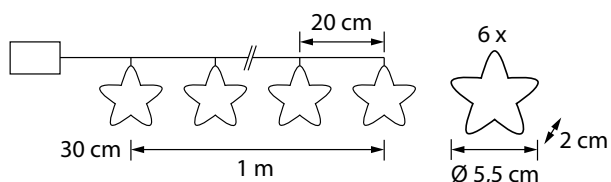

Nr 9478597



6 435200 251046



12



## MINISARJA 40

### KORISTEVALOSARJA MINILAMPUILLA

Monipuoliseen koristeluun. Minilamppu kirkas, ei vaihdettava, kytketty 10 lampun sarjaan. Johto kirkas.

### DEKORATIONSSLINGA MED MINILAMPOR

För många olika dekorationsändamål. Genomskinliga minilampor, ej utbytbara, kopplade i serie om tio lampor. Genomskinlig sladd.

### DECORATIVE MINI-LIGHT-SET WITH MINILAMPS

For a wide variety of decorative purposes. Minilamp clear, non-replaceable, connected with 10 lamps in a series. Clear cord.

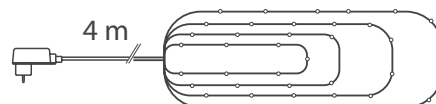

Nr 4107241





PUUVILLAPALLOT JA PALLOSARJAT

Bomullsbollar och bollserier  
Cotton balls and ball series



#### HARMONISTA PALLOPELIÄ.

Airamilta löydät yksinkertaisen kauniit valopallojarjat, joiden värimaailma sointuu pohjolan kotien sisustukseen. Puuvillaisia valopalloja on saatavana monissa kokovaihtoehdoissa. Ota koppi suosikistasi!

#### HARMONISKT BOLLSPEL.

Airam har enkla och vackra ljusbollsserier i färger som harmonierar med inredningar i nordiska hem. Ljusbollar av bomull finns i många olika storlekar. Ta i din favorit!

#### HARMONIOUS BALL GAMES.

Airam has simple, beautiful light ball sets in colours that harmonize with Nordic interior designs. Light balls of cotton are available in many different sizes. Catch your favourite!



## MINNI 20

### LED-LANKAPALLOT

Kattauksiin ja koristeluun sopivat, ohuella puuvillalangalla päällystetyt pallot. Herkulliset värisävyt. Matta tai kiiltävä lanka. LED lämmin valkoinen, ei vaihdettava, kytketty 10 ledin sarjaan. Sisältää paristot. Johto kirkas. On/off-kytkin.

### LED-TRÅDBOLLAR

Bollar beklädda med tunt bomullssnöre, perfekt för dukning och som dekoration. Läckra nyanser. Matt eller glansigt snöre. Varmvita LED-lampor, ej utbytbara, kopplade i serie om tio lampor. Batterier medföljer. Genomsiktig sladd. Av/på-knapp.

### LED COTTON THREAD BALLS

Spheres covered with thin cotton thread for decoration and table-setting. Delicious tones! Matte or gloss thread. LED warm white, non-replaceable, connected with 10 LEDs in a series. Batteries included. Clear cord. On/off switch.



Champagne  
Kiiltävä/ Glansig/ Glossy  
Nr 9477912



6 435200 218087



Lemon  
Matta/ matt/ matte  
Nr 9477925



6 435200 220349



Coffee  
Matta/ matt/ matte  
Nr 9477927



6 435200 220387



Beige  
Matta/ matt/ matte  
Nr 9476048



6 435200 207098



Si-va/ Blå-vitt/ Blue-wht  
Matta/ matt/ matte  
Nr 9477991



6 435200 235640

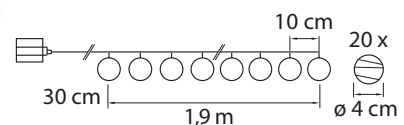





## MILJA 10

### LED-LANKAPALLOT

Sisustukseen sopivat, ohuella puuvillalangalla päällystetyt pallot. Herkulliset värisävyt. Matta tai kiiltävä lanka. LED lämmin valkoinen, ei vaihdettava, kytketty 10 ledin sarjaan. Johto kirkas.

### LED-TRÅDBOLLAR

Bollar beklädda med tunt bomullssnöre, perfekt för heminredning. Läckra nyanser. Matt eller glansigt snöre. Varmvita LED-lampor, ej utbytbara, kopplade i serie om tio lampor. Genomskinlig sladd.

### LED COTTON THREAD BALLS

Spheres covered with thin cotton thread for decoration. Delicious tones! Matte or gloss thread. LED warm white, non-replaceable, connected with 10 LEDs in a series. Clear cord.



Champagne  
Kiiltävä/ Glansig/ Glossy

Nr 9477921



6 435200 220240



6



Lemon  
Matta/ matt/ matte

Nr 9477922



6 435200 220264



6



Coffee  
Matta/ matt/ matte

Nr 9477924



6 435200 220400



6



Beige  
Matta/ matt/ matte

Nr 9476052



6 435200 207173



6



Si-va/ Blå-vitt/ Blue-wht  
Matta/ matt/ matte

Nr 9477889



6 435200 218582



6

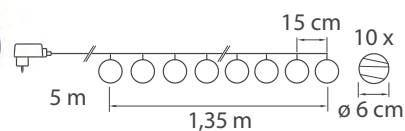

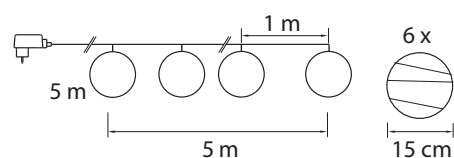

## MILJA 6, Ø 15 CM

### LED-LANKAPALLOT

Upeat ja isot, ohuella puuvillalangalla päällystetyt pallot (6 kpl, Ø 15 cm), sisustukseen sopivissa sävyissä. Pinoa tai aseta roikkumaan näyttäväksi kokonaisuudeksi. LED 48 kpl: 8 kpl/pallo, lämmin valkoinen, ei vaihdettava, kytketty 8 ledin sarjaan. Johto kirkas.

### LED-TRÅDBOLLAR

Snygga, stora dekorationsbollar (6 st, Ø 15 cm) beklädda med tunn bomullstråd i färgtoner som passar olika inredningsstilar. Stapla eller häng upp till en vacker inredningsdetalj. 48 st. varmvita LED-lampor (8 st/boll), ej utbytbara, kopplade i serie om åtta lampor. Genomskinlig sladd.

### LED COTTON THREAD BALLS

Beautiful, large decorative balls (6 pcs, Ø 15 cm) covered with thin cotton thread, in décor-friendly tones. Stack or hang up to create impressive and creative decorations. LED 48 pcs: 8 pcs/ball, warm white, non-replaceable, connected with 8 LEDs in a series. Clear cord.



Valkoinen/ Vit/ White, Ø 15 cm

Nr 9477956



6 4 3 5 2 0 0 2 3 4 8 8 9

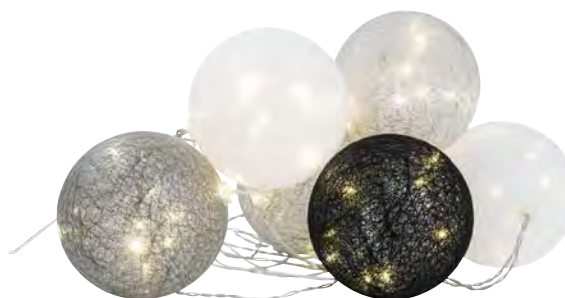

Coffee, Ø 15 cm

Nr 9477957



6 4 3 5 2 0 0 2 3 4 9 0 2



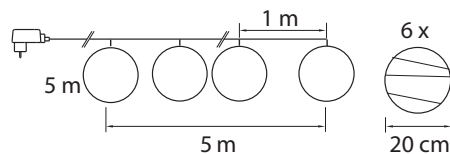

Valkoinen/ Vit/ White, Ø 20 cm

Nr 9477954



## MILJA 6, Ø 20 CM

### LED-LANKAPALLOT

Näyttävät ja suuret, ohuella puuvillalangalla päällystetyt pallot (6 kpl, Ø 20 cm), sisustukseen sopivissa sävyissä. Pinoa tai aseta roikkumaan näyttäväksi kokonaisuudeksi. LED 60 kpl: 10 kpl/pallo, lämmin valkoinen, ei vaihdettava, kytketty 10 ledin sarjaan. Johto kirkas.

### LED-TRÅDBOLLAR

Imponerande, stora dekorationsbollar (6 st, Ø 20 cm) beklädda med tunn bomullstråd i färgtoner som passar olika inredningsstilar. Stapla eller häng upp till en vacker inredningsdetalj. 60 st. varmvita LED-lampor (10 st/boll), ej utbytbara, kopplade i serie om tio lampor. Genomskinlig sladd.

### LED COTTON THREAD BALLS

Impressive, large decoration balls (6 pcs, Ø 20 cm) covered with thin cotton thread, in décor-friendly tones. Stack or hang up to create impressive and creative decorations. LED 60 pcs: 10 pcs/ball, warm white, non-replaceable, connected with 10 LEDs in a series. Clear cord.



Coffee, Ø 20 cm

Nr 9477955



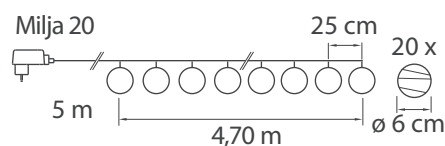

Valkoinen/ Vit/ White

Nr 9477027



6 435200 196200



6

## MILJA 20

### LED-LANKAPALLOT

Sisustukseen sopivat pitkät lankapallosarjat, joissa ohuella puuvillalangalla päällystetyt pallot. Kaksi eri sävyä. Led lämmin valkoinen, ei vaihdettava, kytketty 10 ledin sarjaan. Johto kirkas.

### LED-TRÅDBOLLAR

Långa ljusslingor med bollar beklädda med ett tunt bomullsnöre, perfekt för heminredning. Tillgängliga i två nyanser. Varmvita LED-lampor, ej utbytbara, kopplade i serie om tio lampor. Genomskinlig sladd.

### LED COTTON THREAD BALLS

Sets of spheres covered with thin cotton thread on longer wires for decoration. Two different tones. LED warm white, non-replaceable, connected with 10 LEDs in a series. Clear cord.



Värimix/ Färgmix/ Colour mix

Nr 9477018



6 435200 195982



6

**NEW**

IP44

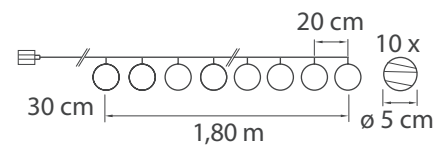
LED  
1010 000  
H3 x  
AA

## CANDY IP44

### PALLOSARJA

Pallosarja, jossa on kaunis pintakuviointi. Paristokotelo on suojattu vesiroiskeilta ja soveltuu siksi myös ulkokäyttöön. Palloissa valittavissa kaksi eri värisävyä. LED lämmin valkoinen, ei vaihdettava. Sisältää paristot ja ajastimen. Materiaali muovi, johto kirkas. On/off- ja ajastinkytkin.

### BOLLSERIE

En bollserie med vacker ornamentering. Batterifodralet är skyddat mot vattenstänk och lämpar sig därför även för utomhusbruk. Bollarna finns i två olika färgtoner. LED varmvit, ej utbyttbar. Innehåller batterier och en timer. Tillverkad av plast, genomskinlig sladd. Av-/på- och timerknapp.

### BALL SET

A set of beautifully ornamented balls. As the battery casing is protected against splashes, it is suitable for outdoor use. The balls come in two different shades. LED warm white, non-replaceable. Batteries and timer included. Made of plastic, clear cord. On/off and timer switch.

Valkoinen/ Vit/ White

Nr 9478513



6 435200 246295



Pastel-mix

Nr 9478514



6 435200 246318





IKKUNA- JA  
SEINÄKORISTEET

Fönster- och  
väggdekorationer

Window and Wall  
Decorations



#### MILLAINEN KOTI, SELLAISET IKKUNAT.

Olipa sisustustyyli millainen vain, Airamien ikkunakoristeista löydät etsimäsi. Somista vaikka joka huoneen ikkuna erilaiseksi ja napsauta valot päälle: kelpaa tonttujen kurkkia sisään.

#### SÅDANT HEM, SÅDANA FÖNSTER.

Oavsett vilken inredningsstil du gillar hittar du vad du söker bland Airams fönsterdekorationer. Varför inte pynta varje fönster olika och tända ljuset? Då kan till och med tomtarna titta in.

#### A HOME IS KNOWN BY ITS WINDOWS.

Whatever your style of decor, Airam has the right window dressing for you. Dress up each window differently, switch on the lights and wait for the elves to come peeking.



## HYPNOS

### KORISTEYMPYRÄ

Näyttävä hopean sävyinen ikkunakoriste. Ympyrä muodostuu useista sisäkkäin olevista levyistä, joista jokaisen voi taittaa kevyesti eri kulmaan, muodostaen kolmiulotteisen vaikutelman. Koristeen keskellä on hiutalekuvio. LED lämmin valkoinen, ei vaihdettava. Materiaali metalli. Johto kirkas.

### DEKORATIONSCIRKEL

En imponerande fönsterdekoration med silverton. Cirkeln består av flera skivor som är inne i varandra. Varje skiva kan lätt vikas i en annan vinkel för att bilda en tredimensionell effekt. Mitt i dekorationen finns ett snöflingemönster. Varmvita LED-lampor, ej utbytbara. Material: metall. Genomskinlig sladd.

### DECORATIVE CIRCLE

An impressive silver-toned window decoration. The circle consists of several discs inside each other. Each disc can easily be folded in a different angle to create a three-dimensional impression. There is a snowflake pattern in the middle of the decoration. LED warm white, non-replaceable. Material: metal. Clear cord.

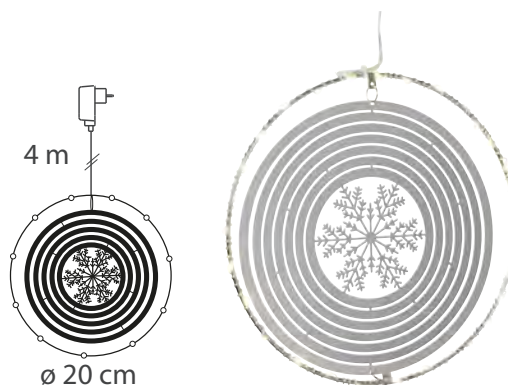

Aloita taivuttaminen varovasti keskeltä. Börja böja försiktig från mitten. Begin to bend carefully from the center.





NEW

IP20

LED  
3010 000  
H

dc 31V 3,6W



## HYPNOS

### KORISTETÄHTI

Upea hopean sävyinen ikkunakoriste, joka luo kolmiulotteisen vaikutelman. Tähti muodostuu useista sisäkkäin olevista levyistä, joista jokaisen voi taivuttaa kevyesti eri kulmaan. LED lämmin valkoinen, ei vaihdettava. Materiaali metalli. Johto kirkas.

### DEKORATIONSSTJÄRNA

En fin fönsterdekoration med silverton. Ger en tredimensionell effekt. Stjärnan består av flera skivor som är inne i varandra. Varje skiva kan lätt vikas i en annan vinkel. Varmvita LED-lampor, ej utbytbara. Material: metall. Genomskinlig sladd.

### DECORATIVE STAR

A beautiful silver-toned window decoration creating a three-dimensional impression. The star consists of several plates inside each other. Each plate can easily be folded in a different angle. LED warm white, non-replaceable. Material: metal. Clear cord.

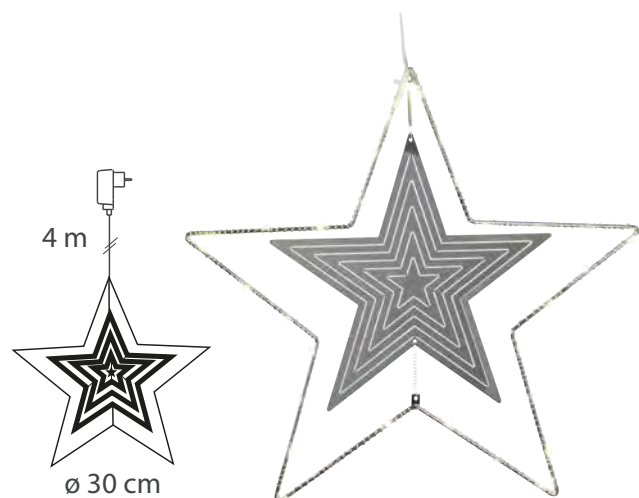

Aloita taivuttaminen varovasti keskeltä.  
Börja böja försiktig från mitten.  
Begin to bend carefully from the center.

Nr 9478551



6 435200 246554



12



## ANNE

### HELMISYDÄN

Sydämen koristeena runsaasti helmiä. LED lämmin valkoinen, ei vaihdettava. Materiaali metallikehikko, helmikoristeet kirkas ja harmaa. Sisältää paristot. Paristot kapeassa metalliputkessa, jossa myös ripustuslenkki. Johto kirkas.

### PÄRLHJÄRTA

Hjärta med vacker pärldekoration. Varmvita LED-lampor, ej utbytbara. Material: metallstomme, genomskinliga eller grå pärldekorationer. Batterier medföljer. Batterierna finns i ett smalt metallrör, som också har en ögla för upphängning. Genomskinlig sladd.

### PEARL HEART

The heart is generously decorated with pearls. LED warm white, non-replaceable. Material: metal frame, white and silver pearl decorations. Batteries included. Batteries inside a narrow metal tube that also has a loop for hanging. Clear cord.

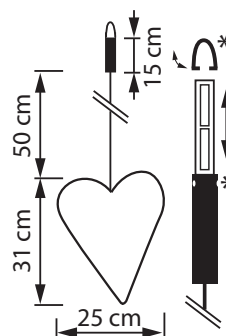



## OILI

### HELMITÄHTI

Tähden koristeena runsaasti helmiä. LED lämmin valkoinen, ei vaihdettava. Materiaali metallikehikko, helmikoristeet valkoinen ja hopea. Sisältää paristot. Paristot kapeassa metalliputkessa, jossa myös ripustuslenkki. Johto kirkas.

### PÄRLSTJÄRNA

Stjärna med vacker pärldekoration. Varmvita LED-lampor, ej utbytbara. Material: metallstomme, pärldekorationer i vitt och silver. Batterier medföljer. Batterierna finns i ett smalt metallrör, som också har en ögla för upphängning. Genomskinlig sladd.

### PEARL STAR

The star is generously decorated with pearls. LED warm white, non-replaceable. Material: metal frame, white and silver pearl decorations. Batteries included. Batteries inside a narrow metal tube that also has a loop for hanging. Clear cord.

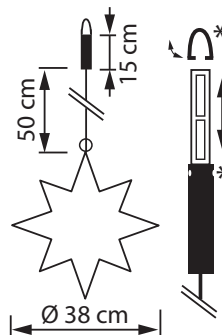

Nr 9478033



6 435200 235008





## LACE

### HIUTALESYDÄN

Kaunis ikkunakoriste, jossa valkoiset hiutalekuviot on aseteltu sydämen muotoon. LED lämmin valkoinen, ei vaihdettava. Sisältää paristot. Materiaali muovi. Johto kirkas. On/off-kytkin.

### SNÖFLINGEHJÄRTA

En vacker fönsterdekoration med vita snöflingemönster som bildar ett hjärta. Varmvita LED-lampor, ej utbytbara. Batterier medföljer. Material: plast. Genomskinlig sladd. Av/på-knapp.

### SNOWFLAKE HEART

A beautiful window decoration with white snowflake patterns arranged in the shape of a heart. LED warm white, non-replaceable. Batteries included. Material: plastic. Clear cord. On/off switch.

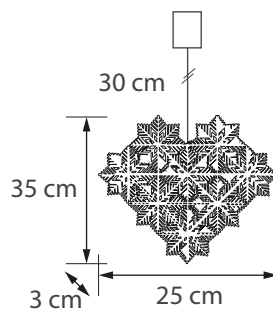

Nr 9478544





## MOMENT

### LED-IKKUNATÄHTI

Tähden koristeena hopeakiteitä. LED lämmin keltainen, ei vaihdettava, kytketty 10 LEDin sarjaan. Materiaali metalli. Johto kirkas.

### LED-FÖNSTERSTJÄRNA

Stjärna utsmyckad med silverkristaller. Varmgula LED-lampor, ej utbytbara, kopplade i serie om tio lampor. Material: metall. Genomskinlig sladd.

### LED WINDOW STAR

The star is adorned with silver crystals. LED warm yellow, non-replaceable, connected with 10 LEDs in a series. Material: metal. Clear cord.

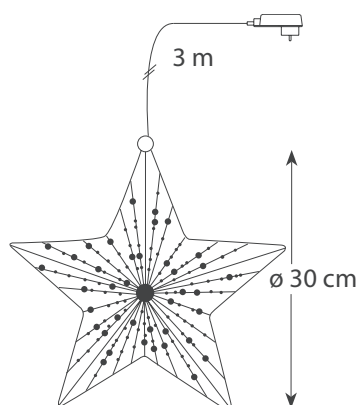

Nr 9477252





## LIANA

### LED-TÄHTI

LED-sarja kauniin metallitähden sisällä. LED lämmin valkoinen, ei vaihdettava, kytketty 10 LEDin sarjaan. Materiaali metalli. Johto kirkas.

### LED-STJÄRNA

LED-slinga inuti vacker metallstjärna. Varmvita LED-lampor, ej utbytbara, kopplade i serie om tio lampor. Material: metall. Genomskinlig sladd.

### LED STAR

A set of LEDs inside a beautiful metal star. LED warm white, non-replaceable, connected with 10 LEDs in a series. Material: metal. Clear cord.

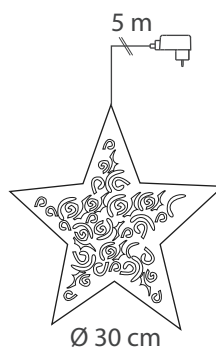

Nr 9476104





## LEENA

### LED-JOULUTÄHDDET

Valkoinen tai messinginvärinen metallitähdi, jonka valaisee tähden sisällä oleva LED-sarja. LED lämmin keltainen, ei vaihdettava, kytketty 10 LEDin sarjaan. Materiaali metalli. Johto kirkas.

### LED-JULSTJÄRNOR

Vit eller mässingsfärgad metallstjärna som lysas upp av en LED-ljusslinga. Varmgula LED-lampor, ej utbytbara, kopplade i serie om tio lampor. Material: metall. Genomsiktig sladd.

### LED CHRISTMAS STARS

A white or brass metal star that is lit by a set of LEDs inside it. LED warm yellow, non-replaceable, connected with 10 LEDs in a series. Material: metal. Clear cord.

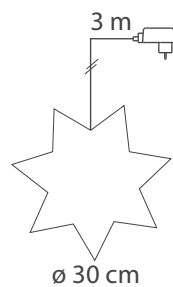

### METALLITÄHTITELINE STÄLLNING MED METALLSTJÄRNOR METAL STAR DISPLAY

Sisältää/ Innehåller/ Contains  
14 x 9476092 Leena  
20 x 9476109 Leena

Valkoinen/ Vit/ White

Nr 9476092



6 435200 213198



Messinki/ Mässing/ Brass

Nr 9476109



6 435200 213174



Teline/ Ställning/ Display

Nr 9476110



6 435200 213211





## EDITH

### SYDÄNKORISTE

Kaunis valkoinen metallisydän, jonka sisällä on led-sarja. LED lämmin valkoinen, ei vaihdettava. Sisältää paristot. Materiaali metalli. Johto kirkas. On/off-kytkin.

### HJÄRTDEKORATION

Ett vackert vitt metallhjärta med en LED-slinga inuti. Varmvita LED-lampor, ej utbytbara. Batterier medföljer. Material: metall. Genomskinlig sladd. Av/på-knapp.

### HEART DECORATION

A beautiful white metal heart with a LED set inside. LED warm white, non-replaceable. Batteries included. Material: metal. Clear cord. On/off switch.

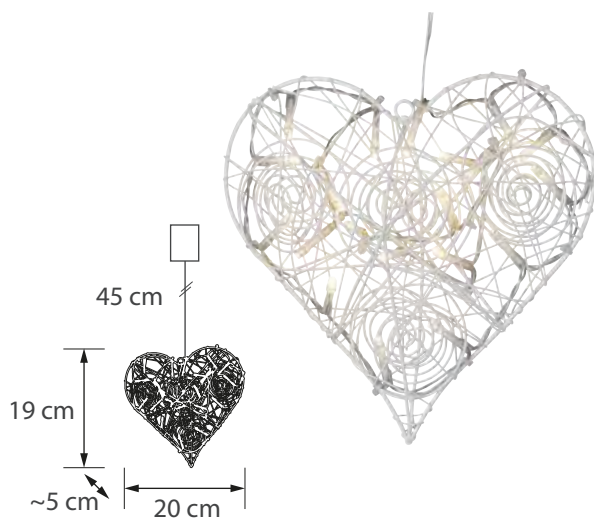

Nr 9478545







## MARION

### METALLIKRANSSI

Tyylikäs valkoinen metallikranssi, jonka ympärille on kieputettu led-sarja. LED lämmin valkoinen, ei vaihdettava. Materiaali metalli. Johto kirkas.

### METALLKRANS

En stilig vit metallkrans med en LED-slinga runtom. Varmvita LED-lampor, ej utbytbara. Material: metall. Genomskinlig sladd.

### METAL WREATH

An elegant white metal wreath with a LED set around it. LED warm white, non-replaceable. Material: metal. Clear cord.

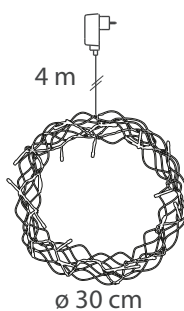

Nr 9478546





## WANDA

### LED-KRANSSI

Kranssi, jossa kirkkaita kidekoristeita taivuteltavissa ruskeissa "oksissa". LED lämmin valkoinen, ei vaihdettava. Sisältää paristot. Materiaali metalli. Johto kirkas. On/off-kytkin.

### LED-KRANS

Krans med genomskinliga kristalldekorationer på bruna, böjliga "kvistar". Varmvita LED-lampor, ej utbytbara. Batterier medföljer. Material: metall. Genomskinlig sladd. Av/på-knapp.

### LED WREATH

A wreath with clear crystal decorations on pliable brown "branches". LED warm white, non-replaceable. Batteries included. Material: metal. Clear cord. On/off switch.

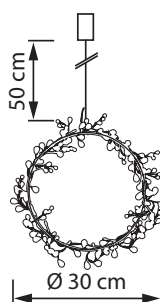

Nr 9478029



6 435200 235169





## CERES IP44

### LED-KRANSSI

Kranssissa kirkaat koristekivet. Mukana ketjut, joilla tuote voidaan asettaa vaaka- tai pystyasentoon. LED lämmin keltainen, ei vaihdettava, kytketty 8 LEDin sarjaan. Materiaali metalli. Johto kirkas.

### LED-KRANS

Krans utsmöckad med genomskinliga stenar. Kedjor medföljer, med vilka produkten kan installeras i horisontellt eller vertikalt läge. Varmgula LED-lampor, ej utbytbara, kopplade i serie om åtta lampor. Material: metall. Genomskinlig sladd.

### LED WREATH

The wreath is adorned with clear decorative gems. Comes with chains that can be used to set up the wreath either vertically or horizontally. LED warm yellow, non-replaceable, connected with 8 LEDs in a series. Material: metal. Clear cord.

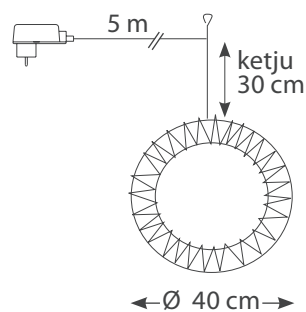

Nr 9476112



PAPERIKORISTEET

Pappersdekorationer  
Paper Decorations





#### TUIKI, TUIKI PAPERITÄHTÖNEN.

Paperi ja valo ovat ajaton yhdistelmä. Airamien paperikoristeista löydät vanhoja ja tulevia klassikoita.

#### BLINKA LILLA PAPPERSSTJÄRNA DÄR.

Papper och ljus är en tidlös kombination. Bland Airams pappersdekorationer hittar du gamla och blivande klassiker.

#### TWINKLE, TWINKLE PAPER STAR.

Paper and light are a timeless combination. Airam's range of paper decorations includes both familiar and future classics.

NEW



9477096 Led  
9477937 Led  
9477098 E14 max 5W



## BEA

### PAPERITÄHDET

Kuvioitu paperitähti, jossa rei'itykset. Suljetaan nauhoilla. Kaksi eri väri vaihtoehtoa. Käytä tähden valaisuun Airam LED-sarjaa nro 9477096 tai 9477937 tai Airam tähtijohtoa nro 9477098 (E14 kanta, LED-lampun teho maks. 5W).

### PAPPERSSTJÄRNOR

En pappersstjärna med figurer och perforering. Stängs med snören. Finns i två olika färger. Använd Airam LED-ljusslinga nr 9477096 eller 9477937, eller Airam stjärnsladd nr 9477098 (E14-sockel, LED-lampans effekt högst 5 W) för att tända stjärnan.

### PAPER STARS

A patterned paper star with perforations. Closed with ribbons. Two different colours. Light the star with Airam LED set no. 9477096 or 9477937, or use Airam's star cord no. 9477098 (E14 socket, max. LED output 5 W).

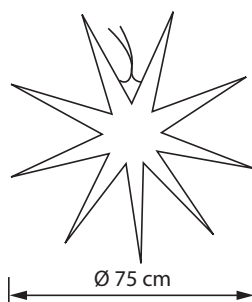

Ø 75 cm

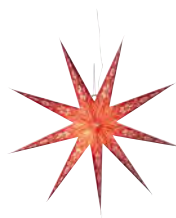

Punavalk./ Rött-vitt/  
Red-white

Nr 9478555



6 435200 246455



6



Harmaavalk./ Grått-vitt/  
Grey-white

Nr 9478556



6 435200 246431



6

NEW



9477096 Led  
9477937 Led  
9477098 E14 max 5W



## BITTI

### PAPERITÄHTI

Trendikäs valkoinen paperitähti. Suljetaan nauhoilla ja tarrakiinnityksellä. Käytä tähden valaisuun Airam LED-sarjaa nro 9477096 tai 9477937 tai Airam tähtijohtoa nro 9477098 (E14 kanta, LED-lampun teho maks. 5W).

### PAPPERSSTJÄRNA

En trendig vit pappersstjärna. Stängs med snören och kardborr. Använd Airam LED-ljusslinga nr 9477096 eller 9477937, eller Airam stjärnsladd nr 9477098 (E14-socket, LED-lampans effekt högst 5 W) för att tända stjärnan.

### PAPER STAR

A trendy white paper star. Closed with ribbons and velcro. Light the star with Airam LED set no. 9477096 or 9477937, or use Airam's star cord no. 9477098 (E14 socket, max. LED output 5 W).

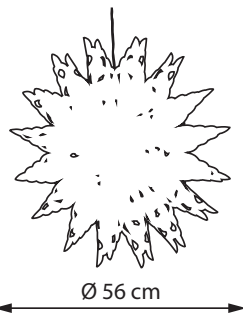

Nr 9478557



6 435200 246356



12



## BOOK

### PAPERIVIUHKA

Avatun kirjan muotoinen paperiviuhka. Viuhkan voi asettaa joko vaaka- tai pystyasentoon. Viuhkaa ei voi sulkea. LED lämmin valkoinen, ei vaihdettava. Sisältää paristot. Materiaali paperi. On/off-kytkin.

### PAPPERSOLFJÄDER

En pappersolfjäder som liknar en öppen bok. Solfjädern kan placeras antingen horisontalt eller vertikalt. Solfjädern kan inte stängas. Varmvita LED-lampor, ej utbytbara. Batterier medföljer. Material: papper. Av/på-knapp.

### PAPER FAN

A paper fan resembling an open book. The fan can be placed either horizontally or vertically. The fan cannot be closed. LED warm white, non-replaceable. Batteries included. Material: paper. On/off switch.

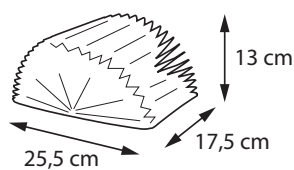

Nr 9478554







9477096 Led  
9477937 Led  
9477098 E14 max 5W



## PIHLA Ø 43 CM

### PAPERITÄHTI

Kaunis, paljettikoristeltu 7-haarainen paperitähti. Suljetaan nauhoilla. Käytä tähden valaisuun Airam LED-sarjaa nro 9477096 tai 9477937 tai Airam tähtijohtoa nro 9477098 (E14 kanta, LED-lampun teho maks. 5W).

### PAPPERSSTJÄRNA

Vacker, sjuuddig pappersstjärna dekorerad med paljetter. Stängs med snören. Använd Airam LED-ljusslinga nr 9477096 eller 9477937, eller Airam stjärnsladd nr 9477098 (E14-sockel, LED-lampans effekt högst 5 W) för att tända stjärnan.

### PAPER STAR

Beautiful, sequined seven-pointed paper star. Closed with ribbons. Light the star with Airam LED set no. 9477096 or 9477937, or use Airam's star cord no. 9477098 (E14 socket, max. LED output 5 W).

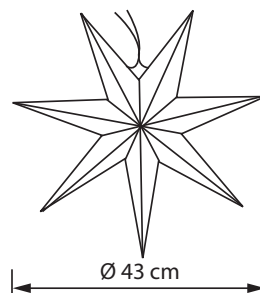



9477096 Led  
9477937 Led  
9477098 E14 max 5W



## PILKE Ø 100 CM

### PAPERITÄHTI

Kauniin pelkistetty, suuri paperitähti. Suljetaan nauhoilla. Käytä tähden valaisuun Airam LED-sarjaa nro 9477096 tai 9477937 tai Airam tähtijohtoa nro 9477098 (E14 kanta, LED-lampun teho maks. 5W).

### PAPPERSSTJÄRNA

Stor, vackert minimalistisk pappersstjärna. Stängs med snören. Använd Airam LED-ljusslinga nr 9477096 eller 9477937, eller Airam stjärnsladd nr 9477098 (E14-socket, LED-lampans effekt högst 5 W) för att tända stjärnan.

### PAPER STAR

A large, beautifully simple paper star. Closed with ribbons. Light the star with Airam LED set no. 9477096 or 9477937, or use Airam's star cord no. 9477098 (E14 socket, max. LED output 5 W).

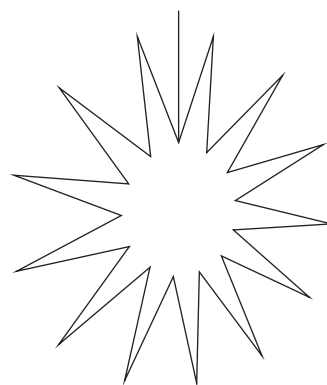

Ø 1 m



Nr 9477935





## HILE Ø 26 CM

### PAPERITÄHTI

Kaunis paperitähti. Tähtien valaisee LED-sarja. LED lämmin valkoinen, ei vaihdettava. Ei sisällä paristoja. Materiaali paperi. Johto kirkas. On/off-kytkin.

### PAPPERSSTJÄRNA

Vackra pappersstjärna. Stjärnan lysas upp av en LED-slinga. Varmvita LED-lampor, ej utbytbara. Batterier ingår inte. Material: papper. Genomskinlig sladd. Av/på-knapp.

### PAPER STAR

A beautiful paper star. The star is lit by a set of LEDs. LED warm white, non-replaceable. Batteries not included. Material: paper. Clear cord. On/off switch.

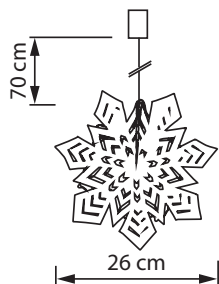

Hiutale/ Flinga/ Flake

Nr 9478039



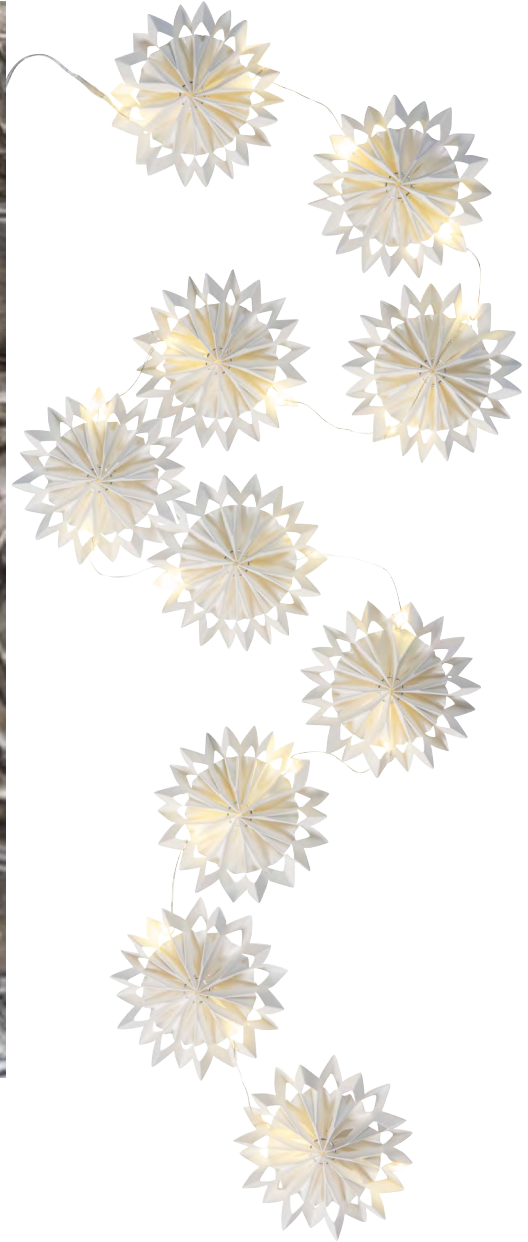

## HILE

### PAPERITÄHTISARJA

Kaunis paperitähtisarja. Hiutalemaisetahdet asettuvat taivuteltavan valolangan avulla haluttuun muotoon. LED lämmin valkoinen, ei vaihdettava. Ei sisällä paristoja. Materiaali paperi, metallilanka. Johto kirkas. On/off-kytkin.

### LJUSSLINGA MED PAPPERSSTJÄRNOR

Vacker ljusslinga med pappersstjärnor. Stjärnorna som liknar snöflingor kan tack vare den böjliga slingan formas som du vill. Varmvita LED-lampor, ej utbytbara. Batterier ingår inte. Material: papper, metalltråd. Genomskinlig sladd. Av/på-knapp.

### PAPER STAR SET

A beautiful set of paper stars. The snowflake-like stars can be arranged into the desired pattern with the pliable light wire. LED warm white, non-replaceable. Batteries not included. Material: paper, metal wire. Clear cord. On/off switch.

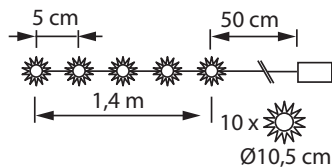

Nr 9478040





## LISÄTARVIKKEET/ TILLBEHÖR/ ACCESSORIES

### PAPERITÄHDEN JOHTO

Paperitähti voidaan valaista käyttämällä tähden sisälle laitettavaa LED-sarjaa. LED-sarjan valo-osuus on taipuisa ja muotoiltavissa. Kaksi eri pituutta. Tuote soveltuu myös muuhun kodin koristamiseen. Kirkas johto + siirrettävä ripustuslenkki.

### LJUSSLINGA TILL PAPPERSSTJÄRNA

Papperstjärnan kan tändas med en LED-slinga som placeras inuti. LED-belysningen kan böjas och formas. Finns i två olika längder. Produkten kan även användas för andra dekorationsändamål i hemmet. Genomsiktig sladd och flyttbar ögla för upphängning.

### CORD FOR THE PAPER STAR

The paper star can be lit using the LED set placed inside the star. The light section of the LED series is flexible and pliable. Two different lengths. Also ideal for other indoor decorations. Clear cord + adjustable hanging loop.



**LED 10**

DC 24V 2VA

LED 10

Nr 9477096

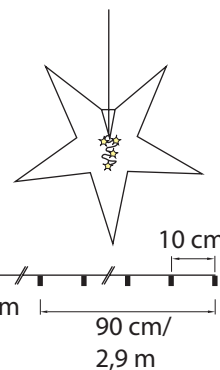

**LED 30**

DC 31V 3,6W

LED 30

Nr 9477937



LASIKORISTEET

Glasdekorationer  
Glass Ornaments





**AIRAM SAA LASINKIN LOISTAMAAN KIRKKAAMMIN.**

Airamien lasikoristeet tuovat harmoniaa ja hillittyä juhlavuutta joulun odotukseen. Joulun on hyvä tulla.

**AIRAM FÅR TILL OCH MED GLAS ATT LYSA KLARARE.**

Airam's glasdekorationer skapar harmoni och en diskret festlighet i väntan på julen. Julen är välkommen.

**AIRAM MAKES THE GLASS GLOW BRIGHTER.**

Airam's glass ornaments bring harmony and understated festivity to Christmas time. 'Tis the season.



## MARIT

### LASISYDÄN

Herkkä kimallekoristeltu lasisydän hehkuu kauniisti esim. ikkunnassa. LED lämmin valkoinen, ei vaihdettava. Materiaali mattalasi. Sisältää paristot. Paristokotelo kapeassa metalliputkessa, jossa myös ripustuslenkki. Johto kirkas. On/off-kytkin.

### GLASHJÄRTA

Vackert glashjärta med glitterdekoration som lyser fint t.ex. i fönstret. Varmvita LED-lampor, ej utbytbara. Material: mattglas. Batterier medföljer. Batterifack i ett smalt metallrör, som även har en ögla för upphängning. Genomskinlig sladd. Av/på-knapp.

### GLASS HEART

The delicate glitter-adorned glass heart provides beautiful shimmering light hanging in a window, for example. LED warm white, non-replaceable. Material: matte glass. Batteries included. Battery casing inside a narrow metal tube that also has a loop for hanging. Clear cord. On/off switch.

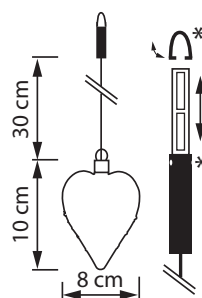





## CLARA

### LASIPALLO

Ajaton helmikoristeltu lasipallo kajastaa kauniisti valoa. LED lämmin valkoinen, ei vaihdettava. Materiaali mattalasi. Sisältää paristot. Paristokotelo kapeassa metalliputkessa, jossa myös ripustuslenkki. Johto kirkas. On/off-kytkin.

### GLASBOLL

Tidlös glasboll med pärldekoration som avger ett vackert sken. Varmvita LED-lampor, ej utbytbara. Material: mattglas. Batterier medföljer. Batterifack i ett smalt metallrör, som även har en ögla för upphängning. Genomsiktig sladd. Av/på-knapp.

### GLASS SPHERE

The timeless glass sphere decorated with pearls shimmers beautiful light. LED warm white, non-replaceable. Material: matte glass. Batteries included. Battery casing inside a narrow metal tube that also has a loop for hanging. Clear cord. On/off switch.

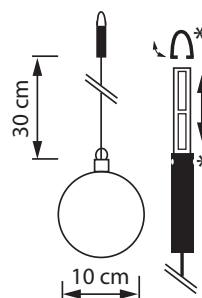



## KAISA

### LASITORNI

Kaunis lasinen koriste joulupöytään tai somisteeksi. LED lämmin valkoinen, ei vaihdettava. Materiaali mattalasi kimallekoristein. Sisältää paristot. On/off-kytkin.

### GLASTORN

Vacker glasdekoration för julbordet eller som prydnad. Varmvita LED-lampor, ej utbytbara. Material: mattglas med glitterdekoration. Batterier medföljer. Av/på-knapp.

### GLASS SPIRE

A beautiful glass ornament for use as a centrepiece for the Christmas meal or as a decoration. LED warm white, non-replaceable. Material: matte glass with glitter decoration. Batteries included. On/off switch.

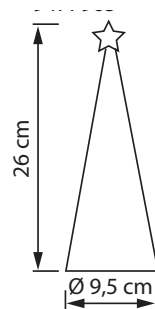

Nr 9477965





## HILDA

### LASIENKELI

Lasinen pöytäkoriste esim. joulusomisteeksi tai lahjaksi. LED lämmin valkoinen, ei vaihdettava. Sisältää paristot. Materiaali mattalasi helmikoristein. On/off-kytkin.

### GLASÄNGEL

Bordsdekoration i glas, kan användas t.ex. som juldekoration eller gåva. Varmvita LED-lampor, ej utbytbara. Batterier medföljer. Material: mattglas med pärldekoration. Av/på-knapp.

### GLASS ANGEL

The glass centrepiece is ideal for Christmas decoration or as a gift, for example. LED warm white, non-replaceable. Batteries included. Material: matte glass with pearl decoration. On/off switch.

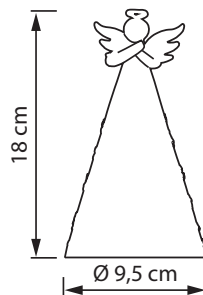

Nr 9477964





## KELLY

### LASIENKELISARJA

Näyttävän lasienkeliisarjan voi asettaa seisomaan haluamallaan tavalla. LED lämmin valkoinen, ei vaihdettava. Sisältää paristot. Materiaali mattalasi kultakoristein. Johto hopeansävyistä ohutta metallilankaa. On/off-kytkin.

### LJUSSLINGA MED GLASÄNGLAR

Elegant ljusslinga med glasänglar som du kan placera som du vill. Varmvita LED-lampor, ej utbytbara. Batterier medföljer. Material: mattglas med gulddekoration. Sladd av tunn, silverfärgad metalltråd. Av/på-knapp.

### GLASS ANGEL SET

The impressive set of glass angels can be positioned as desired. LED warm white, non-replaceable. Batteries included. Material: matte glass with gold decoration. Thin metal wire cord. On/off switch.

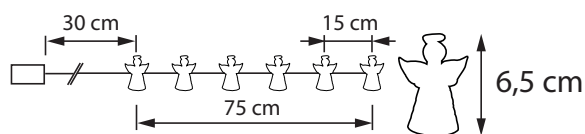

Nr 9477968



6 435200 233554



12



## GAM

### LASILINTU

Kaunis lasinen lintu, jonka sisällä on led-sarja. Paristot ovat putkimallisessa paristokotelossa, jonka yläosa avautuu kiertämällä. LED lämmin valkoinen, ei vaihdettava. Sisältää paristot. Materiaali lasi. Johto hopea.

### GLASFÅGEL

En vacker glasfågel med en LED-slinga inuti. Batterierna finns i ett rörformat batterifodral vars övre del öppnas genom att vrida. Varmvita LED-lampor, ej utbytbara. Batterier medföljer. Material: glas. Silverfärgad sladd.

### GLASS BIRD

A beautiful glass bird with a LED set inside. The batteries are in a tubular battery casing. Open the top by turning. LED warm white, non-replaceable. Batteries included. Material: glass. Silvery cord.

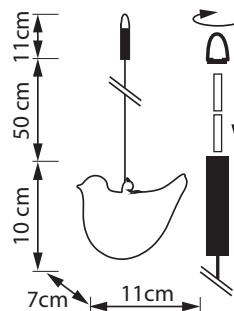

Nr 9478587



LED-KYNTTILÄT,  
-LYHDYT JA -KYNTTELIKÖT

LED-ljus, -lyktor och -ljusstakar  
LED Candles, Lanterns and Candelabra





#### LIEKKI EI HETKESSÄ SAMMU.

Nauti kynttilän lepatuksesta turvallisesti sekä sisällä että ulkona. Airam in moderneilla led-kynttilöillä loihdit näyttäviä esillepanoja ja laajasta kynttelikkövalikoimasta löydät sopivan joka tilanteeseen.

#### LÅGAN SLOCKNAR INTE GENAST.

Njut av stearinljusets flämtande sken på ett tryggt sätt både inne och ute. Med Airams moderna LED-ljus skapar du imponerande arrangemang, och i vårt breda sortiment av ljusstakar hittar du en som passar för varje tillfälle.

#### A FLAME THAT WON'T BE SNUFFED.

Enjoy the flickering candle light safely both indoors and out. Airam's modern LED candles can be used to create impressive displays and the extensive range includes the perfect candle for each situation.



## TINJA

### LED-VAHAKYNTTILÄ

Kaunis tähden muotoinen LED-kynttilä. LED lämmin keltainen, eläväliekkinen, ei vaihdettava. Sisältää paristot. Materiaali muovi, aidon vahakynttilän pinta. On/off-kytkin.

### LED-LJUS I VAX

Ett vackert stjärnformat LED-ljus. Varmgul LED-lampa, flammmande låga, ej utbytbar lampa. Batterier medföljer. Material: plast, yta av äkta vax. Av/på-knapp.

### LED WAX CANDLE

A beautiful star-shaped LED candle. LED warm yellow, "living flame", non-replaceable. Batteries included. Material: plastic with a genuine wax candle surface. On/off switch.

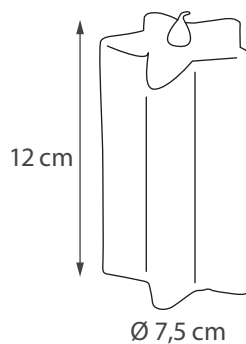

Nr 9478533



12



NEW



LED



10 000  
H



2x  
AA



## TEMPO

### LED-VAHAKYNTTILÄ

Pyöreä pintakuvioitu vahakynttilä, josta valo kajastaa kauniisti. LED lämmin keltainen, eläväliekkinen, ei vaihdettava. Sisältää paristot. Materiaali muovi, aidon vahakynttilän pinta. On/off-kytkin.

### LED-LJUS I VAX

Ett runt ytmönstrat vaxljus som avger ett vackert ljussken. Varmgul LED-lampa, flämmande låga, ej utbytbar lampa. Batterier medföljer. Material: plast, yta av äkta vax. Av/på-knapp.

### LED WAX CANDLE

A round surface-patterned wax candle providing a beautiful, shimmering light. LED warm yellow, "living flame", non-replaceable. Batteries included. Material: plastic with a genuine wax candle surface. On/off switch.

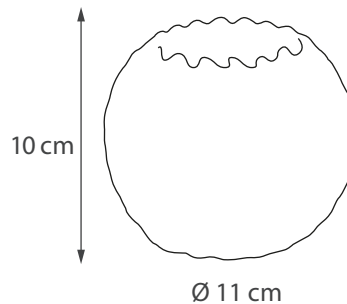

Nr 9478563



6 435200 247841



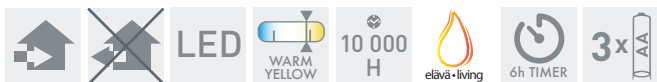

## JENNI

### LED-VAHAKYNTTILÄ

Vaalealla narupunoksella koristeltu LED-kynttilä. LED lämmin keltainen, eläväliekkinen, ei vaihdettava. Sisältää paristot. Materiaali muovi, aidon vahakynttilän pinta. On/off-kytkin.

### LED-LJUS I VAX

LED-ljus med ljus snördekoration. Varmgul LED-lampa, flammande låga, ej utbytbar lampa. Batterier medföljer. Material: plast, yta av äkta vax. Av/på-knapp.

### LED WAX CANDLE

An LED candle decorated with a pale twine braid. LED warm yellow, "living flame", non-replaceable. Batteries included. Material: plastic with a genuine wax candle surface. On/off switch.

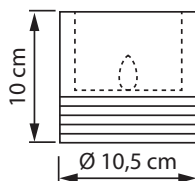

Nr 9478017



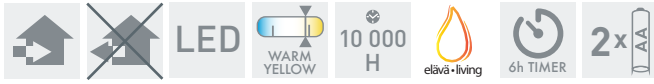

## JUTTA

### LED-VAHAKYNTTILÄ

Kaunis salmiakkikuvioitu LED-kynttilä kajastaa pehmeästi valoa. LED lämmin keltainen, eläväliekkinen, ei vaihdettava. Sisältää paristot. Materiaali muovi, aidon vahakyynttilän pinta. On/off-kytkin.

### LED-LJUS I VAX

Vackert LED-ljus med salmiakrutor som avger ett mjukt ljusken. Varmgul LED-lampa, flämmande låga, ej utbytbar lampa. Batterier medföljer. Material: plast, yta av äkta vax. Av/på-knapp.

### LED WAX CANDLE

The beautiful diamond-patterned LED candle provides a soft, shimmering light. LED warm yellow, "living flame", non-replaceable. Batteries included. Material: plastic with a genuine wax candle surface. On/off switch.

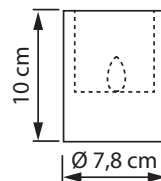

Nr 9477993



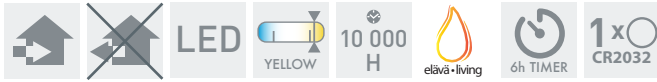

## CINDY

### LED-VAHAKYNTTILÄT

Valkoinen tai punainen LED-vahakynttilä, 6,5 cm. Palaa kauniisti ja turvallisesti. LED keltainen, eläväliekinen, ei vaihdettava. Sisältää paristot. Materiaali muovi, aidon vahakynttilän pinta. On/off-kytkin.

### LED-LJUS I VAX

Vitt eller rött LED-ljus i vax, 6,5 cm. Brinner vackert och tryggt. Gul LED-lampa, flammande låga, ej utbyttbar lampa. Batterier medföljer. Material: plast, yta av äkta vax. Av/på-knapp.

### LED WAX CANDLES

White or red LED wax candle, 6.5 cm. A beautiful and safe light. LED yellow, "living flame", non-replaceable. Batteries included. Material: plastic with a genuine wax candle surface. On/off switch.



Valkoinen/ Vit/ White

Nr 9476174



6 435200 182968

4x12 (48)



Punainen/ Röd/ Red

Nr 9476166



6 435200 187871



4x12 (48)

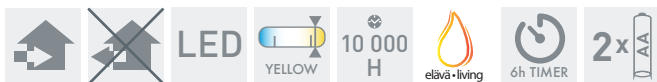

## LED-VAHAKYNTTILÄ

Klassinen LED-vahakynttilä, jonka pinnassa talivalumia. Palaa kauniisti ja turvallisesti. LED keltainen, eläväliekkinen, ei vaihdettava. Sisältää paristot. Materiaali muovi, aidon vahakynttilän pinta. On/off-kytkin.

### LED-LJUS I VAX

Klassiskt LED-ljus i vax med talgdroppar på ytan. Brinner vackert och tryggt. Gul LED-lampa, flammande låga, ej utbytbar lampa. Batterier medföljer. Material: plast, yta av äkta vax. Av/på-knapp.

### LED WAX CANDLE

A classic dripping LED wax candle. A beautiful and safe light. LED yellow, "living flame", non-replaceable. Batteries included. Material: plastic with a genuine wax candle surface. On/off switch.

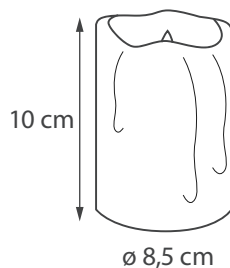

Nr 9477677



6 435200 155771





## ARIMA

### KYNTTILÄPROJEKTORI

Hauska kynttilän mallinen koriste, joka heijastaa kattoon liikkuvia jouluaiheisia kuvia. Tuotetta ei saa osoittaa suoraan silmiin, eikä antaa lasten käyttöön. LED värimix, ei vaihdettava. Sisältää paristot. Materiaali muovi, aidon vahakynttilän pinta. On/off-kytkin.

### VAXLJUSPROJEKTOR

En rolig vaxljusformad dekoration som projicerar rörliga julmotiv på taket. Projektorn får inte riktas mot ögon eller användas av barn. LED färgmix, ej utbytbar lampa. Batterier medföljer. Material: plast, yta av äkta vax. Av/på-knapp.

### CANDLE PROJECTOR

A nice candle-shaped decoration projecting moving Christmas-themed figures onto the ceiling. Do not direct the projector towards eyes. Do not let children use the projector. LED colour mix, non-replaceable. Batteries included. Material: plastic with a genuine wax candle surface. On/off switch.

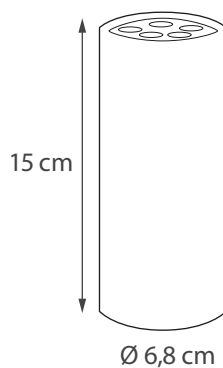

Nr 9478590





## XENA

### LED-VAHAKYNTTILÄSETTI

Setti, jossa kolme helmiäisen vaaleaa LED-kynttilää RGB-toiminnolla. Mukana kaukosäädin, jolla loihdit kynttilöihin eri tunnelmasävyt. Valittavana 12 eri väri vaihtoehtoa, 2 eri ajastinta, moniväri toiminto ja eläväliekkitoiminto. Kaukosäätimen toimintasäde 5 m. LED 1 kpl/kynttilä, kiinteä tai väri vaihtava, ei vaihdettava. Sisältää paristot. Materiaali muovi, aidon vahakyynttilän pinta. On/off-kytkin.



### LED-LJUSSET I VAX

Set med tre pärlmorglänsande, ljusa LED-ljus med RGB-funktion. Fjärrkontroll medföljer, med vilken du kan ställa in olika stämningfulla nyanser för ljusen. Tolv olika färgalternativ, två olika timerinställningar, flerfärgsfunktion och funktion med flammmande låga. Fjärrkontrollens räckvidd 5 m. 1 st. LED-lampa/ljus, med fast eller skiftande färg, ej utbytbar. Batterier medföljer. Material: plast, yta av äkta vax. Av/på-knapp.

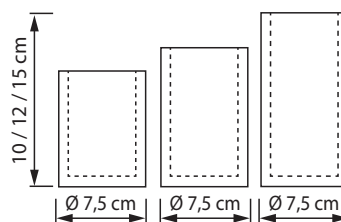

### LED WAX CANDLES

A set of three pale pearlescent LED candles with an RGB mode. Includes a remote control that can be used to change the colour of the candles to suit different moods. 12 different colour options, 2 different timers, a multi-colour mode, and a living flame function. The operating radius of the remote control is 5 metres. 1 LED per candle, solid or colour-changing, non-replaceable. Batteries included. Material: plastic, genuine wax candle surface. On/off switch.





## SALLY

### LED-VAHAKYNTTILÄT

LED-kynttilä, jossa kimalteleva ja ruudutettu pinta. Telineessä kolme kaunista sävyä: hopea, punainen ja kulta. LED lämmin keltainen, ei vaihdettava. Sisältää paristot. Materiaali muovi, aidon vahakynttilän pinta. On/off-kytkin.

### LED-LJUS I VAX

LED-ljus med glimmande, rutig yta. Finns i tre vackra nyanser: silver, röd och guld. Varmgula LED-lampor, ej utbytbara. Batterier medföljer. Material: plast, yta av äkta vax. Av/på-knapp.

### LED WAX CANDLES

An LED candle with a sparkly check-patterned surface. The holder includes three beautiful shades: silver, red and gold. LED warm yellow, non-replaceable. Batteries included. Material: plastic with a genuine wax candle surface. On/off switch.

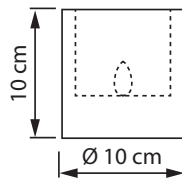

Nr 9478018





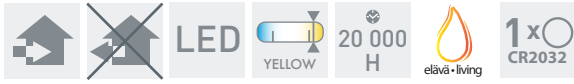

## LED-MINIKYNTTILÄ

Turvallinen vaihtoehto tuikkukynttilöiden tilalle. Ei kuumene eikä leimahda. LED keltainen, eläväliekkinen, ei vaihdettava. Pakkauksessa kaksi kynttilää ja neljä paristoa. Materiaali muovi. On/off-kytkin.

### LED-MINILJUS

Ett tryggt alternativ till värmeljus. Hettas och flammor inte upp. Gul LED-lampa, flammmande låga, ej utbytbar lampa. Två st ljus och fyra st batterier i förpackningen. Material: plast. Av/på-knapp.

### LED MINI CANDLES

A safe alternative to tea lights. Does not heat or flare up. LED yellow, "living flame", non-replaceable. Two candles and four batteries in the packaging. Material: plastic. On/off switch.

Nr 9476130



6 435200 12718 1



2 cm



ø 3,8 cm



### MINIKYNTTILÄTELIN STÄLLNING MED LED-MINILJUS LED MINI CANDLE DISPLAY

Sisältää/ Innehåller/ Contains  
60 x 9476130 Led-minikynttilä/  
LED-miniljus/ LED mini candle blister

Nr 9476140



6 435200 13522 3





## RUBY IP44

### LYHTYKYNTTILÄ

Ulkokäyttöön, esim. pihalyhtyihin soveltuva LED-kynttilä IP44 suojatulla paristokotelolla. LED lämmin keltainen, eläväliekkinen, ei vaihdettava. Sisältää paristot. Materiaali muovi. On/off-kytkin.

### LYKTLJUS

LED-ljus för utomhusbruk med batterifack med skyddsklass IP44, t.ex. till gårdslyktorna. Varmgul LED-lampa, flammande låga, ej utbytbar lampa. Batterier medföljer. Material: plast. Av/på-knapp.

### LANTERN CANDLE

An outdoor LED candle for yard lanterns, for example, equipped with an IP44 protected battery case. LED warm yellow, living flame, non-replaceable. Batteries included. Material: plastic. On/off switch.

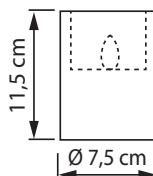

Nr 9477994





## MUISTO 12 CM IP44

### HAUTAKYNTTILÄ RISTIKUVIOLLA

Ristikuvioin koristeltu LED-hautakynnä. LED keltainen, eläväliekinen, ei vaihdettava. Sisältää paristot. Materiaali muovi. On/off-kytkin.

### GRAVLJUS MED KORSMÖNSTER

Gravljus med korsmönster. Gul LED-lampa, flammande låga, ej utbytbar. Batterier medföljer. Material: plast. Av/på-knapp.

### MEMORIAL CANDLE WITH CROSSES

An LED memorial candle with a cross motif. LED yellow, "living flame", non-replaceable. Batteries included. Material: plastic. On/off switch.

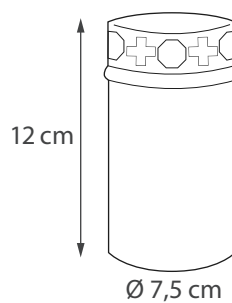

Nr 9477884



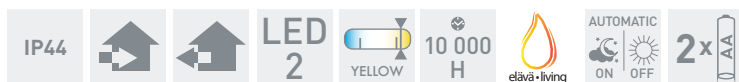

## MUISTO 13 CM IP44

### HAUTAKYNTTILÄ HÄMÄRÄKYTKIMELLÄ

Pitkäikäinen LED-hautakynnätilä hämärekytkimellä. Syttyy ja sammuu automaattisesti. LED keltainen, eläväliekkinen, ei vaihdettava. Sisältää paristot. Materiaali muovi. On/off-kytkin.

### GRAVLJUS MED SKYMNINGSSENSOR

LED-gravlykta med lång livslängd och skymningssensor. Tänds och släcks automatiskt. Gul LED-lampa, flammande låga, ej utbytbar lampa. Batterier medföljer. Material: plast. Av/på-knapp.

### MEMORIAL CANDLE WITH A DUSK SWITCH

An LED memorial candle with a dusk switch and long lifespan. Lights up and turns off automatically. LED yellow, "living flame", non-replaceable. Batteries included. Material: plastic. On/off switch.

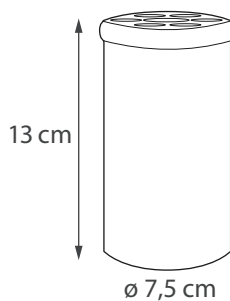

Nr 9476155



NEW



LED  
46



10 000  
H



4x  
AAA



## SERATA

### LOIMULIEKKILYHTY

Perinteistä myrskylyhtyä muistuttava koriste, jossa komea loimuliekkiefekti. Voidaan käyttää katetuilla terasseilla. LED keltainen ja valkoinen, ei vaihdettava. Sisältää paristot. Materiaali valkoinen metalli ja muovi. On/off-kytkin.

### LYKTA MED FLAMMANDE EFFEKT

En dekoration som liknar en traditionell stormlykta och som har en fin flammade effekt. Kan användas på övertäckta terrasser. Gul och vit LED-lampa, ej utbytbara. Batterier medföljer. Material: vit metall och plast. Av/på-knapp.

### LANTERN WITH A FLAMING EFFECT

A decoration resembling a traditional storm lantern and having an excellent flaming effect. It can be used in covered terraces. LED yellow and white, non-replaceable. Batteries included. Materials: white metal and plastic. On/off switch.

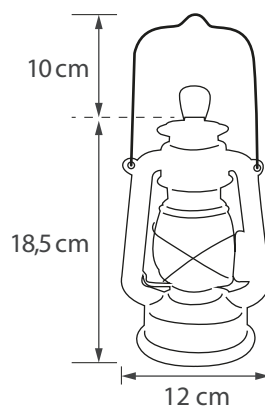

Nr 9478591



**NEW**

IP44

LED  
46

YELLOW



WHITE

10 000  
H

elävä-living



6h TIMER

4x



## CLARION

### LOIMULIEKKILYHTY

Perinteistä myrskylyhtyä muistuttava koriste, jossa sekä komea loimuliekkiefekti että kiinteä valkoinen valo. Voidaan käyttää katetuilla terasseilla. LED keltainen ja valkoinen, ei vaihdettava. Sisältää paristot. Materiaali harmaa metalli ja muovi. On/off-kytkin.

### LYKTA MED FLAMMANDE EFFEKT

En dekoration som liknar en traditionell stormlykta och som har både en fin flammade effekt och ett vanligt vitt ljus. Kan användas på övertäckta terrasser. Gul och vit LED-lampa, ej utbytbara. Batterier medföljer. Material: grå metall och plast. Av/på-knapp.

### LANTERN WITH A FLAMING EFFECT

A decoration resembling a traditional storm lantern and having both an excellent flaming effect and a normal white light. It can be used in covered terraces. LED yellow and white, non-replaceable. Batteries included. Materials: grey metal and plastic. On/off switch.

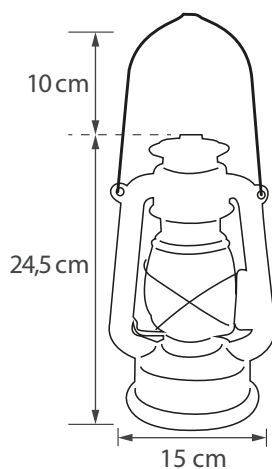

Nr 9478592



6 435200 250513





## SAGA

### LOIMULIEKKILYHTY

Perinteinen lyhtymalli, jossa näyttävä loimuliekkiefekti.  
LED keltainen, ei vaihdettava. Sisältää paristot. Materiaali muovi.  
On/off-kytkin.

### LYKTA MED FLAMMANDE EFFEKT

En traditionell modell med imponerande flammande effekt.  
Gul LED-lampa, ej utbyttbar. Batterier medföljer. Material: plast.  
Av/på-knapp.

### LANTERN WITH A FLAMING EFFECT

A traditional model with an impressive flaming effect.  
LED yellow, non-replaceable. Batteries included. Material: plastic.  
On/off switch.

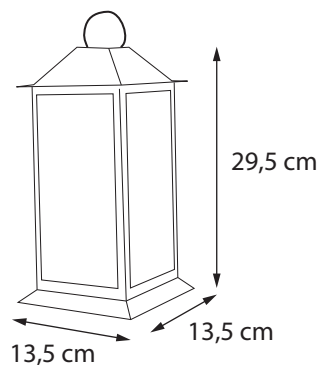

Nr 9478535





## CAMINO

### KORISTETAKKA/ TAKKALYHTY

Takkaa jäljittelevä koriste, jossa tunnelmallinen ja turvallinen leimu ilman savua ja tulta. Ei kuumene. LED keltainen, liekkiefekti, ei vaihdettava. Sisältää paristot. Materiaali musta metalli ja lasi. On/off-kytkin.

### DEKORATIV BRASA/ BRASLYKTA

En dekoration som liknar en brasa och har en trygg, stämningfull glöd utan rök och eld. Blir inte het. Gul LED-lampa, flammmande effekt, ej utbytbar. Batterier medföljer. Material: svart metall och glas. Av/på-knapp.

### DECORATIVE FIREPLACE/ FIREPLACE LANTERN

A decoration resembling a fireplace and having a safe and cosy glow without smoke or fire. Does not get hot. LED yellow, flaming effect, non-replaceable. Batteries included. Materials: black metal and glass. On/off switch.

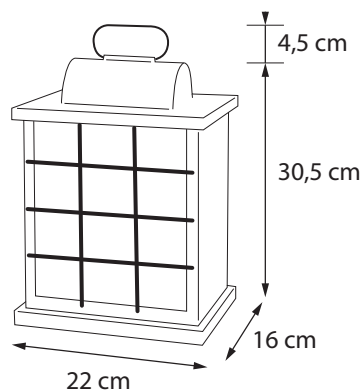

Nr 9478593







## EINI

### LED-LYHTY

Valikoimassa kolme eri väristä koristelyhtyä: valkoinen, antiikkiharmaa tai sinivihreä. Telineessä eniten harmaata sävyä. LED keltainen, eläväliekkinen, ei vaihdettava. Sisältää paristot. Materiaali muovi. On/off-kytkin.

### LED-LYKTA

Dekorativa lyktor i tre olika färger: vit, antikgrå eller blågrön. I ställningen mest grå ton. Gul LED-lampa, flammande låga, ej utbytbar lampa. Batterier medföljer. Material: plast. Av/på-knapp.

### LED LANTERN

The selection contains three decorative lanterns in different colours: white, antique grey or bluish green. In the rack mostly grey shades. LED yellow, "living flame", non-replaceable. Batteries included. Material: plastic. On/off switch.

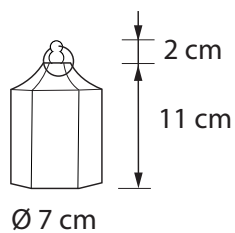

Nr 9476062



6 435200 207661



6 harmaa / grå / grey  
3 Antiikki / antik / antique  
12 (6/3/3)  
3 sin.-vihr. / blå-grön / blue-green



## PAULA

### LED-KYNTTELIKKÖ

Valkoinen kynttelikkö, jossa tähtirei'itetyt metalliset kynttiläkupit. Ledin eläväl liekki tuo aidon tunnelman. LED lämmin keltainen, eläväl liekki, ei vaihdettava. Sisältää paristot. Materiaali metalli. On/off-kytkin.

### LED-LJUSSTAKE

En vit ljusstake med stjärnperforerade ljuskoppar av metall. Den flammmande lågan ger äkta stämning. Varmgula LED-lampor, flammmande låga, ej utbytbara. Batterier medföljer. Material: metall. Av/på-knapp.

### LED CANDELABRUM

A white candelabrum with star-perforated metal candle cups. The "living flame" creates a genuine atmosphere. LED warm yellow, "living flame", non-replaceable. Batteries included. Material: metal. On/off switch.

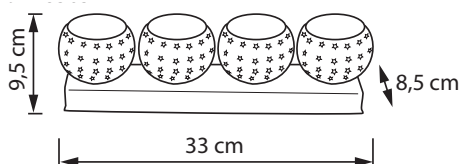

Nr 9478565





## GRACE

### LED-KYNTTELIKKÖ

Ajattomassa kynttelikössä on koristeena metalliholkit. LED lämmin valkoinen, ei vaihdettava. Materiaali muovi. Johto kirkas.

### LED-LJUSSTAKE

Tidlös ljusstake med ljushylsor av metall. Varmvita LED-lampor, ej utbytbara. Material: plast. Genomsiktig sladd.

### LED CANDELABRUM

The timeless candelabrum is adorned with metal sleeves. LED warm white, non-replaceable. Material: plastic. Clear cord.

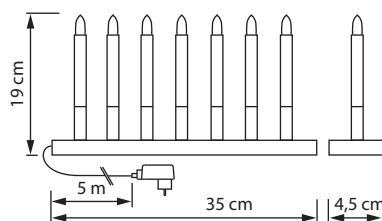

Nr 9477995





## KATHRIN

### LED-KYNTTELIKÖT

Tyylikäs korkea kynttelikkö, jossa näyttävät tähtisovitteet. Kaksi eri sävyä. LED lämmin valkoinen, ei vaihdettava. Materiaali metalli ja muovi. Johto kirkas.

### LED-LJUSSTAKE

En elegant hög ljusstake med imponerande stjärnmönster. Två olika toner. Varmvita LED-lampor, ej utbytbara. Material: metall och plast. Genomskinlig sladd.

### LED CANDELABRA

An elegant tall candelabrum with impressive star patterns. Two different shades. LED warm white, non-replaceable. Materials: metal and plastic. Clear cord.



Hopea-musta/ Silver-svart/  
Silver-black

Nr 9478560



6 435200 250070



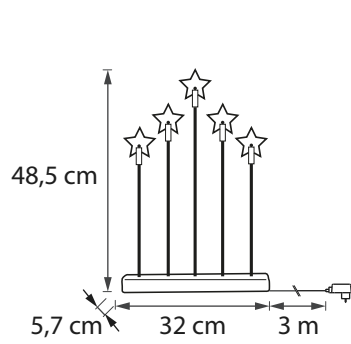

Kupari-musta/ Kopparsvart/  
Copper-black

Nr 9478561





## SHEILA

### LED-KYNTTELIKKÖ

Valkoinen kynttelikkö, jossa kiinteät tähtikehykset. LED lämmin valkoinen, ei vaihdettava. Sisältää paristot. Materiaali metalli ja muovi. Johto kirkas. On/off-kytkin.

### LED-LJUSSTAKE

En vit ljusstake med fasta stjärnramar. Varmvita LED-lampor, ej utbytbara. Batterier medföljer. Material: metall och plast. Genomskinlig sladd. Av/på-knapp.

### LED CANDELABRUM

A white candelabrum with fixed star frames. LED warm white, non-replaceable. Batteries included. Materials: metal and plastic. Clear cord. On/off switch.

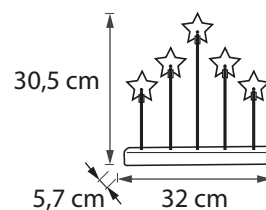

Nr 9478564





## NICO

### LED-KYNTTELIKKÖ

Metsäaiheinen kevytrakenteinen silhuettikoriste. LED-valo puissa. LED lämmin valkoinen, ei vaihdettava, rinnankytketty. Materiaali metalli. Johto musta.

### LED-LJUSSTAKE

Sirlig silhuettedekoration med skogstema. LED-lampor i träden. Varmvita LED-lampor, ej utbytbara, parallellkopplade. Material: metall. Svart sladd.

### LED CANDELABRUM

A forest-themed delicate silhouette ornament. LEDs in the trees. LED warm white, non-replaceable, parallel connection. Material: metal. Black cord.

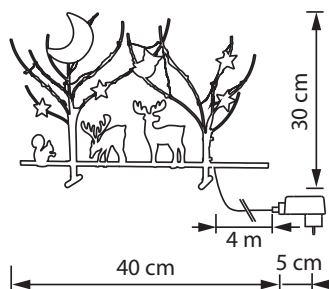

Nr 9477998





## SILJA

### LED-KYNTTELIKKÖ

Valkoinen, punainen tai puunvärinen LED-kynttelikkö. LED lämmin keltainen, ei vaihdettava, rinnankytketty. Materiaali puuta. Johto kirkas. On/off-kytkin.

### LED-LJUSSTAKE

Vit, röd eller träfärgad LED-ljusstake. Varmgula LED-lampor, ej utbytbara, parallellkopplade. Material: trä. Genomskinlig sladd. Av/på-knapp.

### LED CANDELABRUM

White, red or wood-coloured LED candelabrum. LED warm yellow, non-replaceable, parallel connection. Material: wood. Clear cord. On/off switch.

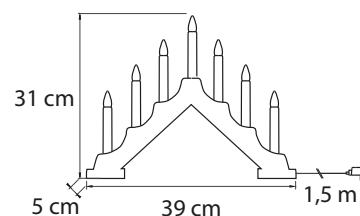

Valkoinen/ Vit/ White  
Nr 9476905







Punainen/ Röd/ Red

Nr 9476906



Puunvärinen  
Träfärgad  
Wood-coloured

Nr 9476907





## JOULUPUKIN VIRALLINEN KUMPPANI

© SANTA CLAUS FOUNDATION™

### JOULUPUKKI SUOSITTELEE:

Joulupukki, jos kuka, tietää, mitkä tuotteet sopivat ihan joka kotiin. Airam on Joulupukin virallisena valontuojana edistämässä maailman lasten hyvinvointia. Lue lisää Joulupukkisäätiöstä: <https://santaclausfinland.fi/joulupukkisaatio/>

### JULTOMTEN REKOMMENDERAR:

Om någon vet vilka produkter som passar i precis varje hem så är det Jultomten. Som Jultomtens officiella ljusbringare är Airam med och främjar välbefinnandet hos alla världens barn. Läs mer om Jultomtens stiftelse: <https://santaclausfinland.fi/joulupukkisaatio/>

### RECOMMENDED BY SANTA CLAUS:

If anyone should know the perfect products for each and every home, it's Santa Claus. As the official light provider for Santa Claus, Airam promotes the wellbeing of the children of the world. Read more about the Santa Claus Foundation at <https://santaclausfinland.fi/en/joulupukkisaatio/>

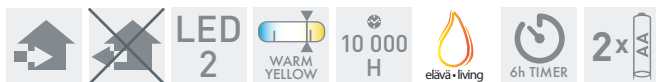

## SANDRA

### LED-KYNTTILÄT

Vahakynttilä, jossa liikkuva liekki antaa elävän kynttilänvalon tunnun. LED lämmin keltainen, liikkuva eläväliekki, ei vaihdettava. Sisältää paristot. Materiaali muovi. Aidon vahakynttilän pinta. On/off kytkin.

### LED-LJUS I VAX

Vaxljus med rörlig låga som ger ett naturtroget, flammande sken. Varmgul LED-lampa, rörlig, flammande låga, ej utbytbar lampa. Batterier medföljer. Material: plast. Yta av äkta vax. Av/på-knapp.

### LED WAX CANDLES

A wax candle with a shifting flame that provides the feel of living candle light. LED warm yellow, shifting living flame, non-replaceable. Batteries included. Material: plastic. Genuine wax candle surface. On/off switch.



Valkoinen/ Vit/ White

Nr 9477866



6 435200 177094



12

Harmaa/ Grå/ Grey

Nr 9478020



6 435200 235046



12



## LED-IKKUNA

### IKKUNAKORISTE

Kynttilät 4 kpl kukin omassa ruudussaan. 2 kpl ripustusketjuja.  
Led lämmin keltainen, ei vaihdettava, rinnankytketty. Materiaali muovi. Johto kirkas.

### LED-FÖNSTER

4 st. ljus, vart och ett i en egen öppning. 2 st. kedjor för upphängning. Varmgula LED-lampor, ej utbytbara, parallellkopplade. Material: plast. Genomsiktig sladd.

### LED WINDOW

Four candles each in their own square. Two hanging chains. LED warm yellow, non-replaceable, parallel connection. Material: plastic. Clear cord.

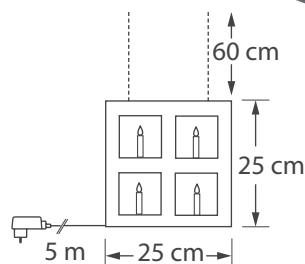

Nr 9477938



6 435200 225887





## LED-LATVATÄHTI

### KUUSENKORISTE

Hopeanvärinen tähti. Koristeena helmiä ja kimalletta, mukana asennusjalka 15 cm. LED lämmin valkoinen, ei vaihdettava, kytketty 10 LEDin sarjaan. Johto kirkas.

### LED-TOPPSTJÄRNA

Stjärna i silver. Dekorerad med pärlor och glitter, fot på 15 cm för montering ingår. Varmvita LED-lampor, ej utbytbara, kopplade i serie om tio lampor. Genomskinlig sladd.

### LED TREETOP STAR

Silver-coloured star. Decorated with pearls and glitter. Comes with a 15 cm mount. LED warm white, non-replaceable, connected with 10 LEDs in a series. Clear cord.

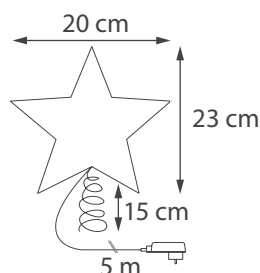

Nr 9476340



9477012  
9477736



## LED-KUUSENKYNTTILÄSARJA

### KUUSENKYNTTILÄT

Kauniit mattapintaiset kynttilät yhdessä nauhassa, ei ympyräkettuja. LED mattapintainen, vaihdettava, rinnankytketty. Varalampun nro 9477012 tai 9477736. Johto vihreä.

### LED-JULGRANSBELYSNING

Vackra ljus med matt yta monterade i slinga och inte i loop. LED-lampor med matt yta, utbytbara, parallellkopplade. Reservlampans nr: 9477012 eller 9477736. Grön sladd.

### LED CHRISTMAS TREE LIGHT SET

Beautiful matte-surfaced candles on a single string, not in a looping chain. LED matte surface, replaceable, parallel connection. No. of spare LED-bulb 9477012 or 9477736. Green cord.

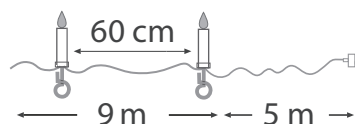

Nr 9477010





## JOULUPUKKI SUOSITTELEE

### TUOTETELINE

Airam on ainoa virallinen Joulupukin valontuoja. Tuotetelineessä on kattava valikoima perinteisiä LED-joulukoristeita. Joulupukkisäätiö edistää maailman lasten hyvinvointia ja lahjoittaa vuosittain Joulupukin Lahjan maailman lapsille. Ostamalla Joulupukin suositteleman tuotteen, olet mukana antamassa lahjaa maailman lapsille.

### PRODUKTSTÄLLNING

Airam är Jultomtens enda officiella ljusbringare. Produktställningen innehåller ett brett utbud av traditionella LED-juldekorationer. Jultomtens stiftelse främjar välbefinnandet hos barn runt om i världen och donerar årligen Jultomtens Gåva till förmån för världens barn. Genom att köpa en produkt som Jultomten rekommenderar är du med och ger en gåva till världens barn.

### PRODUCT STAND

Airam is the only official light provider for Santa Claus. The product stand includes a wide selection of traditional LED Christmas ornaments. The Santa Claus Foundation promotes the wellbeing of children throughout the world and annually donates the Santa's Gift to the children of the world. By buying a product recommended by Santa, you contribute to the gift to the children of the world.

Sisältää/ Innehåller/ Contains

- 5 x 9478020 Sandra va/vit/white
- 5 x 9477866 Sandra ha/grå/grey
- 6 x 9476340 Latvatähti ho/silver/silver
- 8 x 9477938 Led-jouluikkuna
- 6 x 9477010 Led-kuusenkynttiläsarja

Teline/ Ställning/ Display

Nr 9478041



6 435200 238436

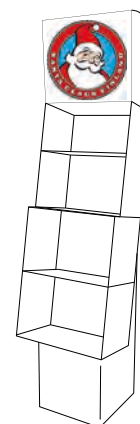

A photograph of a decorated Christmas tree in a living room. The tree is a dark green, conical shape, densely covered with warm white string lights. At the top is a large, five-pointed star topper made of thin wire and lights. The tree stands on a black metal stand. At its base are three wrapped gifts in silver paper with white ribbons. To the left is a white wooden chair. To the right is a white wooden radiator and a white ceramic deer figurine with large antlers. In the background, a window with white frames looks out onto a landscape. On the windowsill are two square, frosted glass candle holders. To the left, a white shelf holds several white ceramic vases. The overall lighting is soft and warm, creating a cozy holiday atmosphere.

KUUSENKYNTTILÄT  
JA LATVATÄHDET

Julgransbelysning och  
toppstjärnor

Christmas Tree Candles  
and Tree Top Stars





#### AIRAM TEKEE JOULUN.

Airamin valot ovat vuosikymmenten aikana kuulleet lukemattoman määrän joululauluja. Tutuin niistä lienee Joulupuu on rakennettu. Kiitos yhteisistä joulunvietoista: nähdään ensi jouluna!

#### AIRAM GÖR JULEN.

Airams lampor har under årtionden hört otaliga julsånger. En av de mest kända är antagligen Nu tändas tusen juleljus. Tack för alla jular vi har fått fira tillsammans: vi ses igen nästa jul!

#### AIRAM BRINGS CHRISTMAS.

Over decades, the lights of Airam have heard countless Christmas carols being sung around the Christmas tree. Thank you for the Christmases we have shared and we hope to see you again next year!



## JUNO

### LATVATÄHDET

Kaunis latvatähti, kaksi eri sävyä. LED lämmin valkoinen, ei vaihdettava. Sisältää paristot. Materiaali metalli. Johto kirkas. On/off-kytkin.

### TOPPSTJÄRNOR

Vacker, mässingsfärgad toppstjärna i två olika färger. Varmvita LED-lampor, ej utbytbara. Batterier medföljer. Material: metall. Genomskinlig sladd. Av/på-knapp.

### TREETOP STARS

Elegant star tree topper in two different colours. LED warm white, non-replaceable. Batteries included. Material: metal. Clear cord. On/off switch.

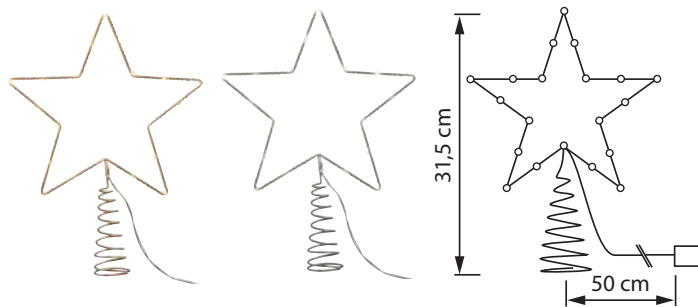

Messinki/ Mässing/ Brass

Nr 9478038



6 435200 238450



Hopea/ Silver

Nr 9478501



6 435200 242099



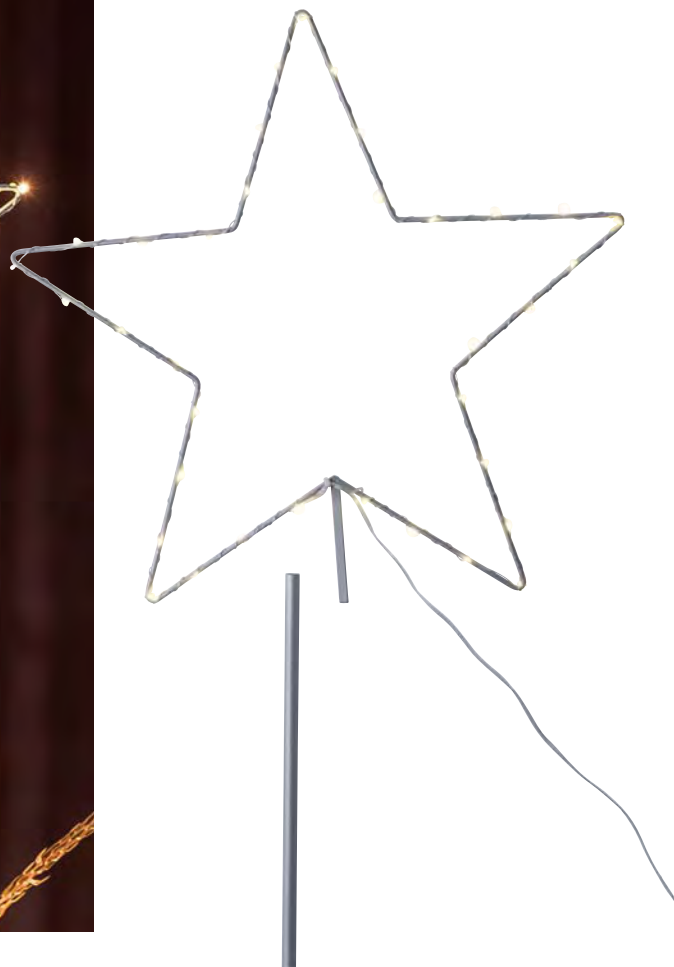
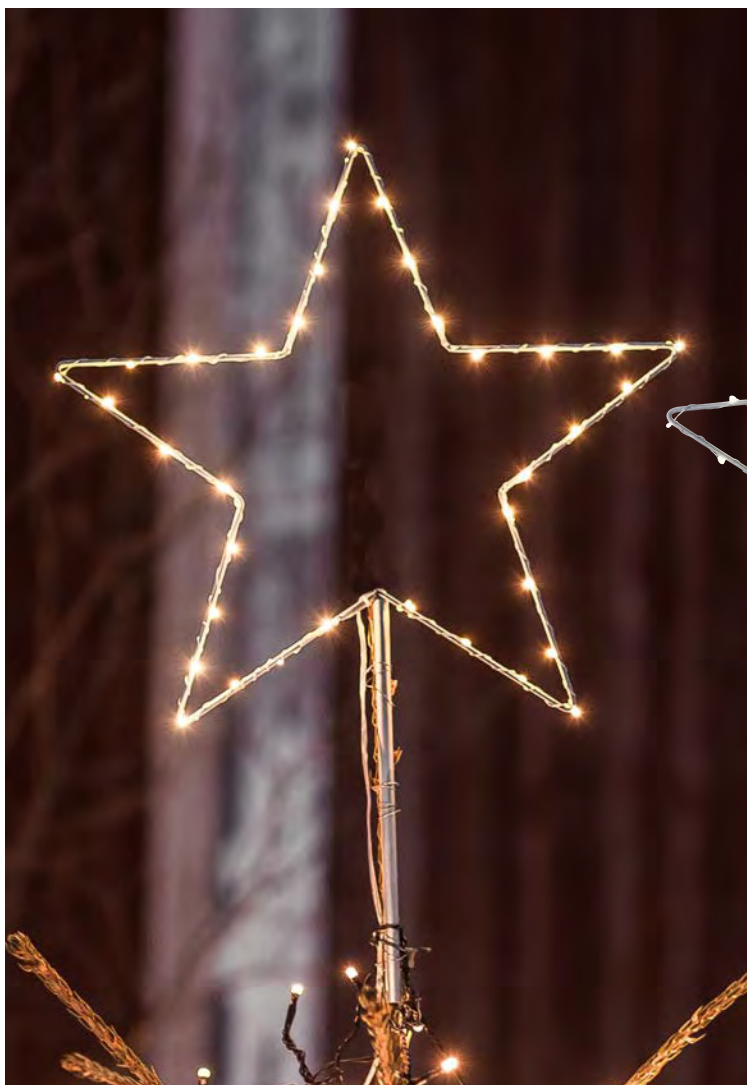

## LISA IP44

### LATVATÄHTI

Ulkokäyttöön soveltuva reilun kokoinen latvatähti pihan kauneimpaan kuuseen. LED lämmin valkoinen, ei vaihdettava. Materiaali metalli. Mukana nippusiteet ja kiinnitysalku. Johto tumma.

### TOPPSTJÄRNA

Stor toppstjärna för utomhusbruk till gårdens vackraste gran. Varmvita LED-lampor, ej utbytbara. Material: metall. Buntband och fastsättning medföljer. Mörk sladd.

### TREETOP STAR

A larger tree topper suitable for outside use to adorn the most magnificent spruce in the yard. LED warm white, non-replaceable. Material: metal. Comes with plastic ties and a mount. Dark cord.

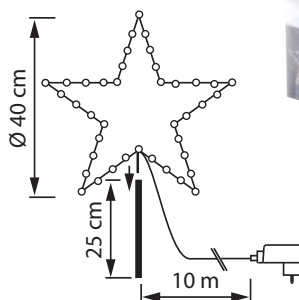

Nr 9477999





## KIMMEL

### KUUSENKYNTTILÄSARJA

Kaunis kuusenkynttiläsarja, jossa koko valkoiset, erityisen kapeat kynttilät ja tumma vihreä klipsi. LED lämmin valkoinen, ei vaihdettava, rinnankytketty. Materiaali muovi ja metalli. Johto tumma vihreä.

### JULGRANSBELYSNING

Vacker julgransbelysning med helvita, extra smala ljus och mörkgrön klämma. Varmvita LED-lampor, ej utbytbara, parallellkopplade. Material: plast och metall. Mörkgrön sladd.

### CHRISTMAS TREE CANDLES

An elegant Christmas tree candle set, with thin, white candles, and dark green mounting clips. LED warm white, non-replaceable, parallel connection. Material: plastic and metal. Dark green cord.

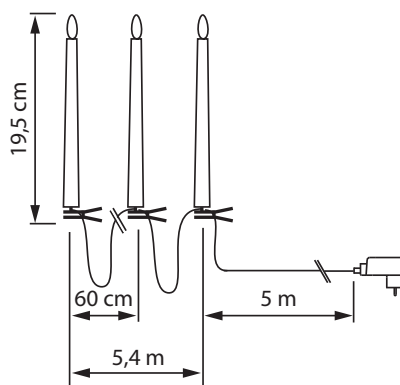

Nr 9478035



9477325  
9477324



## RETRO 16

### VALKOINEN LED-KUUSENKYNTTILÄSARJA

Valkoisein kuusiin tai koristekohteisiin. Valkoiset kääntyvät kiinnikkeet, joilla kynttilät on helppo suoristaa. LED lämmin keltainen, vaihdettava, rinnankytketty. LED-varalampun nro 9477325 tai 9477324. Materiaali muovi. Johto valkoinen.

### VIT LED-JULGRANBELYSNING

För vita granar och andra dekorationsändamål. Vita, svängbara klämmor som gör det enkelt att rätta upp ljusen. Varmgula LED-lampor, utbytbara, parallellkopplade. Reservlampans nr: 9477325 eller 9477324. Material: plast. Vit sladd.

### WHITE LED CHRISTMAS TREE LIGHT SET

For white Christmas trees or other decorative purposes. Rotating white clips that allow you to easily straighten the candles. LED warm yellow, replaceable, parallel connection. Product code for spare bulb (LED): 9477325 or 9477324. Material: plastic. White cord.

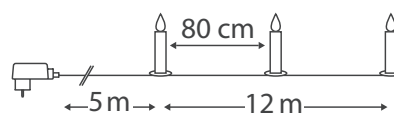

Nr 9476996



IP20



4719242

3W 14V  
Pikyp  
E10

230V



## DELUX 16 IP20

### KUUSENKYNTTILÄSARJA

16:n kynttilän valosarja. Kestävä ja riittävästi aukeava kiinnike. Kynttilät yhdessä nauhassa, ei ympyräketjua. Lamppu 3W 14V Pikyp E10, vaihdettava. Varalampun nro 4719242. Johto vihreä. Jännite 230V.

### JULGRANSBELYSNING

Ljusslinga med 16 ljus. Hållbar klämma som öppnar sig brett. Monterade i slinga och inte i loop. Lampa 3W 14V Pikyp E10, utbytbara lampor. Reservlampans nr: 4719242. Grön sladd. Spänning 230 V.

### CHRISTMAS TREE LIGHT SET

A light series with 16 candles. Durable clip with a convenient wide opening. Candles on a single string, not in a looping chain. Bulb 3W 14V Pikyp E10, replaceable. Product code for spare lamp 4719242. Black cord. Voltage 230 V.

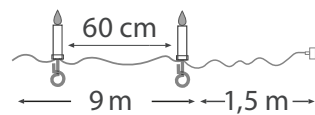

Nr 9477000



6 435200 130099



12

## DELUX DISPLAY 64

Sisältää/ Innehåller/ Contains:

44 x 9477000 Delux 16 IP20 sisäkäyttöön/ för inomhusbruk/  
for indoor use20 x 4106002 Delux 16 IP44 ulkokäyttöön/ för utomhusbruk/  
for outdoor use

Nr 4207048



6 435200 009715



1

IP44



230V



## DELUX 16 & 30 IP44

### KUUSENKYNTTILÄSARJAT

16 tai 30 kynttilän valosarja, kestävä ja riittävästi aukeava kiinnike. Kynttilät yhdessä nauhassa, ei ympyräketjua. Delux 16: 3W 14V Pikyp E10 (varalampun nro 4719242), Delux 30: 3W 8V Pikyp E10 (varalampun nro 4779302), vaihdettava. Johto musta. Suojausluokka IP44, jännite 230V.

### JULGRANSBELYSNING

Ljusslinga med 16 eller 30 ljus, hållbar klämma som öppnar sig brett. Monterade i slinga och inte i loop. Delux 16: 3W 14V Pikyp E10 (reservlampans nr 4719242), Delux 30: 3W 8V Pikyp E10 (reservlampans nr 4779302), utbytbara lampor. Svart sladd. Skyddsklass IP44, spänning 230 V.

### CHRISTMAS TREE LIGHT SETS

A set of lights with 16 or 30 candles. Durable clip with a convenient wide opening. Candles on a single string, not in a looping chain. Delux 16: 3 W 14 V Pikyp E10 (Product code for spare lamp 4719242), Delux 30: 3 W 8 V Pikyp E10 (Product code for spare lamp 4779302), replaceable. Black cord. IP44 protection rating, voltage 230 V.

4719242

3W 14V  
Pikyp  
E10

Delux 16 IP44

Nr 4106002



6 435200 116505



12

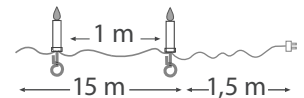

4779302

3W 8V  
Pikyp  
E10

Delux 30 IP44

Nr 4106003



6 435200 116529



12

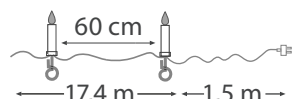

**NEW****LED****10 000 H****1x AAAA**kynttilä  
ljus  
candle**1x CR2032**kaukosäädin  
fjärrkontroll  
remote control

## AURORA IP44

### KAUKO-OHJATTAVAT KUUSENKYNTTILÄT

Setti irrallisia, johdottomia paristotoimisia kuusencynttilöitä. Voidaan asettaa myös katettuun ulkotilaan. Kynttilöiden eri toimintoja ohjataan kaukosäätimellä: säädä valon voimakkuutta ja liekkitoimintaa. Kaukosäätimen ajastustoiminnolla kynttilät sytyvät automaattisesti. Kynttilän voi irrottaa pidikkeestä ja asettaa esim. tavalliseen kynttilänjalkaan. LED 1 kpl/kynttilä, lämmin valkoinen, ei vaihdettava. Sisältää paristot. Materiaali muovi.

### FJÄRRSTYRD JULGRANSBELYSNING

Ett set lösa, sladdlösa, batteridrivna julgransljus. Kan även användas utomhus under tak. Ljusens olika funktioner styrs med fjärrkontroll: man kan ställa in ljusstyrkan och flameffekten. Med fjärrkontrollens timerfunktion tänds ljusen automatiskt. Ljusen kan användas i en vanlig ljusstake efter att klämmorna har tagit bort. 1 LED-lampa per ljus, varmvita, ej utbytbara. Batterier medföljer. Material: plast.

### REMOTE-CONTROLLED CHRISTMAS TREE CANDLES

A set of separate, cordless, battery-operated Christmas tree candles. Can also be used outdoors under a roof. The different functions of the candles are controlled with a remote control device: adjust brightness and flame effect. With the device's timer function, the candles are lit automatically. The candles can be used in a regular candelabra after the clips have been removed. One LED per candle, warm white, non-replaceable. Batteries included. Material: plastic.



Nr 9478549



6 435200 249890



12



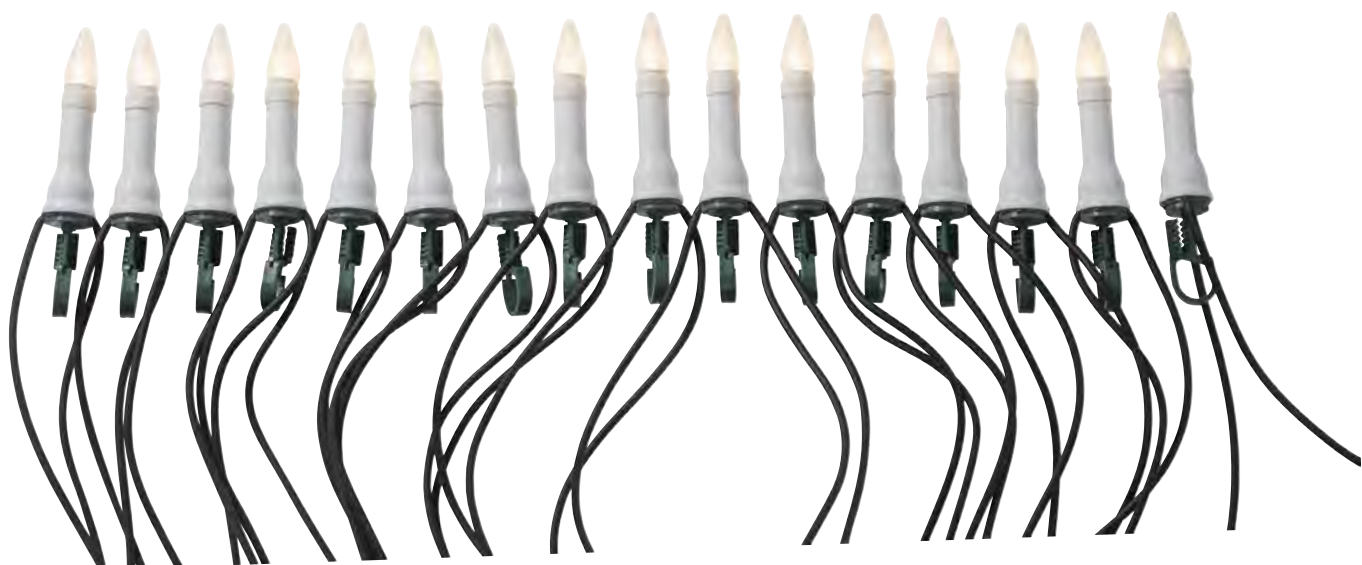

## WINTER 16 & 30 IP44

### LED-KUUSENKYNTTILÄSARJAT

Ulkokäyttöön soveltuva kuusenkynntiläsarja, 16 tai 30 kynttilää. LED lämmin valkoinen, ei vaihdettava, rinnankytketty. Materiaali muovi ja metalli. Johto tumma.

### LED-JULGRANSBELYSNING

Julgransbelysning för utomhusbruk, 16 eller 30 ljus. Varmvita LED-lampor, ej utbytbara, parallellkopplade. Material: plast och metall. Mörk sladd.

### LED CHRISTMAS TREE LIGHT SETS

A set of Christmas tree lights for outdoor use, 16 or 30 candles. LED warm white, non-replaceable, parallel connection. Material: plastic and metal. Dark cord.



Winter 16 IP44

Nr 9478036

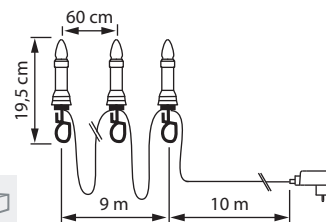

Winter 30 IP44

Nr 9478037

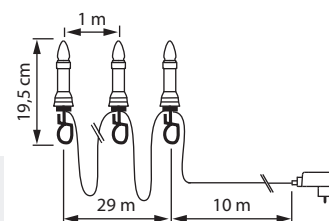

LED-SARJAT (IP44)

LED-slingor (IP44)

LED Sets (IP44)





#### PIMEYS ON TÄYDELLINEN TAUSTA.

Täällä pohjoisessa on helppo inspiroitua valaisemisesta lähes läpi vuoden. Koristele pimeys led-valoilla. Materiaalia riittää isompiinkin valoteoksiin, sillä pituutta led-sarjoilla on parista metristä aina kymmeneen metrihin asti.

#### MÖRKER ÄR EN PERFEKT BAKGRUND.

Här i Norden är det lätt att bli inspirerad av belysning nästan hela året. Dekorera mörkret med LED-ljus. Det finns tillräckligt med material även för större ljusdekorationer - LED-slingorna kan vara mellan ett par och tiotals meter långa.

#### DARKNESS IS A PERFECT BACKGROUND.

Here in our Nordic countries, it is easy to get inspired by illumination almost throughout the year. Decorate the darkness with LED lights. We have material enough for larger light decorations - some LED series are a couple of metres long, others are dozens of metres long.

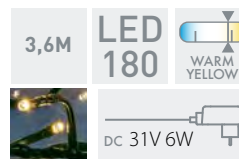

Tumma johto/ Mörk sladd/  
Dark cord  
LED 180, 3,6 m

Nr 9477001



6 4 3 5 2 0 0 1 9 3 2 0 9



6

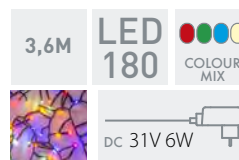

Tumma johto värimix/  
Mörk sladd färgmix/  
Dark cord colour mix  
LED 180, 3,6 m

Nr 9477928



6 4 3 5 2 0 0 2 1 7 9 6 7



6

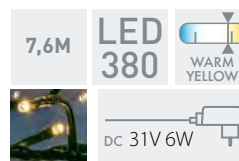

Tumma johto/ Mörk sladd/  
Dark cord  
LED 380, 7,6 m

Nr 9477002



6 4 3 5 2 0 0 1 9 3 2 2 3



6

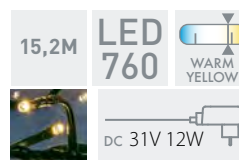

Tumma johto/ Mörk sladd/  
Dark cord  
LED 760, 15,2 m

Nr 9477003



6 4 3 5 2 0 0 1 9 3 2 4 7



4

## ELBE IP44

### LED-SARJAT

Elbe LED-sarjaa on saatavissa kolmessa eri pituudessa: 3,6 m, 7,6 m tai 15,2 m. Saat koristeltua sekä pienet parvekkeet että suuret piha-alueet. LED lämmin keltainen, 3,6 m sarja saatavissa myös värimix. Ei vaihdettava LED, kytketty 10 LEDin sarjaan. Johto kirkas tai tumma.

### LED-SLINGOR

LED-slingan Elbe finns i tre olika längder: 3,6 m, 7,6 m och 15,2 m. Med den kan du dekorera både små balkonger och stora gårdsplaner. Varmgula LED-lampor, slingan på 3,6 m finns även med olika färgers lampor. Ej utbytbara LED, kopplade i serie om tio lampor. Genomskinlig eller mörk sladd.

### LED CHAINS

The Elbe LED set is available in three different lengths: 3.6 m, 7.6 m and 15.2 m. Perfect for decorating both small balconies and larger yards. LED warm yellow, the 3.6 m set also available in colour-mix. Non-replaceable LED, connected with 10 LEDs in a series. Clear or dark cord.

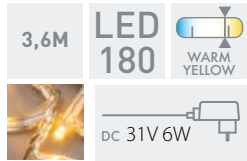

Kirkas johto/ Genomskinlig sladd/ Clear cord  
LED 180, 3,6 m

Nr 9476086  
6 435200 208422



Kirkas johto värimix/ Genomskinlig sladd färgmix/ Clear cord colour mix  
LED 180, 3,6 m

Nr 9477929  
6 435200 217981

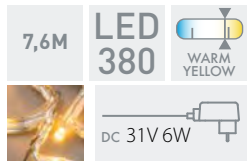
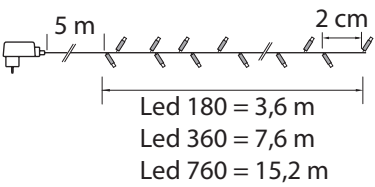

Kirkas johto/ Genomskinlig sladd/ Clear cord  
LED 380, 7,6 m

Nr 9476087  
6 435200 208446

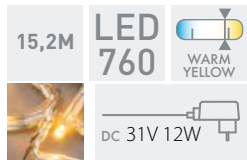

Kirkas johto/ Genomskinlig sladd/ Clear cord  
LED 760, 15,2 m

Nr 9476088  
6 435200 208460



**NEW**

IP44

10 000  
H

## TEAM IP44

### LED-SARJAT

Team LED-sarjaa on saatavissa kolmessa eri pituudessa. LED lämmin keltainen, ei vaihdettava, kytketty 10 LEDin sarjaan. Johto kirkas tai tumma.

### LED-SLINGA

LED-slingan Team finns i tre olika längder. Varmgula LED-lampor, ej utbytbara, kopplade i serie om tio lampor. Genomskinlig eller mörk sladd.

### LED CHAINS

The Team LED set is available in three different lengths. LED warm yellow, non-replaceable, connected with 10 LEDs in a series. Clear or dark cord.



3,9M

LED  
40

Tumma johto/ Mörk sladd/  
Dark cord  
Team 40

Nr 9478571



6 435200 249470



12

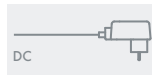

DC



7,9M

LED  
80

Tumma johto/ Mörk sladd/  
Dark cord  
Team 80

Nr 9478572



6 435200 249494



12

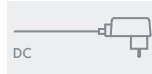

DC



11,9M

LED  
120

Tumma johto/ Mörk sladd/  
Dark cord  
Team 120

Nr 9478573



6 435200 249517



12

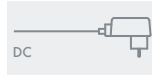

DC

NEW

IP44



10 000 H

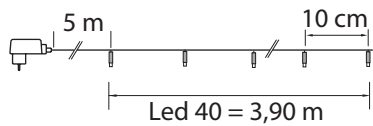

3,9M

LED 40

Kirkas johto/ Genomskinlig sladd/ Clear cord Team 40



Nr 9478574

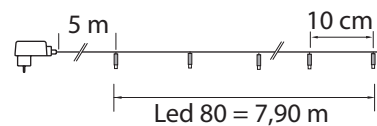

7,9M

LED 80

Kirkas johto/ Genomskinlig sladd/ Clear cord Team 80



Nr 9478575

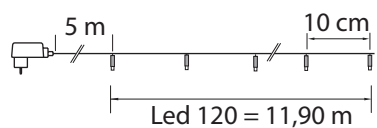

11,9M

LED 120

Kirkas johto/ Genomskinlig sladd/ Clear cord Team 120

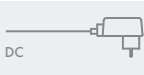

Nr 9478576



**NEW**

IP44

10 000  
H

## LEDIA IP44

### LED-SARJAT

Ulkokäyttöön sopivat LED-sarjat kirkkaalla tai tummalla johdolla. Kirkkaalla johdolla neljä eri mittaa, tummalla jopa kuusi eri pituutta. LED lämmin valkoinen, ei vaihdettava.

### LED-SLINGA

LED-slingor med genomskinlig eller mörk sladd. Kan användas utomhus. Den genomskinliga sladden har fyra olika mått, den mörka har t.o.m. sex olika längder. Varmvita LED-lampor, ej utbytbara.

### LED CHAINS

LED chains with clear or dark cord. Also for outdoor use. The clear cord has four different dimensions, the dark cord has up to six different lengths. LED warm white, non-replaceable.

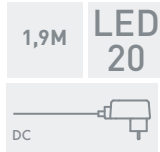

Tumma johto/ Mörk sladd/  
Dark cord  
Ledia 20

Nr 9478577

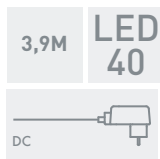

Tumma johto/ Mörk sladd/  
Dark cord  
Ledia 40

Nr 9478578

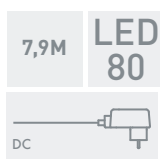

Tumma johto/ Mörk sladd/  
Dark cord  
Ledia 80

Nr 9478579

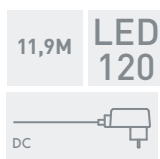

Tumma johto/ Mörk sladd/  
Dark cord  
Ledia 120

Nr 9478580

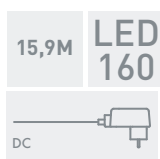

Tumma johto/ Mörk sladd/  
Dark cord  
Ledia 160

Nr 9478581

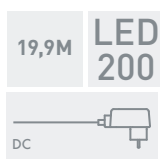

Tumma johto/ Mörk sladd/  
Dark cord  
Ledia 200

Nr 9478582





NEW

IP44



10 000 H



1,9M LED 20



Kirkas johto/ Genomskinlig  
sladd/ Clear cord  
Ledia 20

Nr 9478583  
6 435200 249272



3,9M LED 40



Kirkas johto/ Genomskinlig  
sladd/ Clear cord  
Ledia 40

Nr 9478584  
6 435200 249296



7,9M LED 80



Kirkas johto/ Genomskinlig  
sladd/ Clear cord  
Ledia 80

Nr 9478585  
6 435200 249319



11,9M LED 120



Kirkas johto/ Genomskinlig  
sladd/ Clear cord  
Ledia 120

Nr 9478586  
6 435200 249333

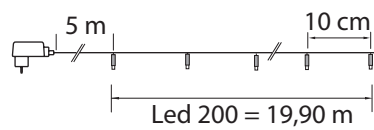
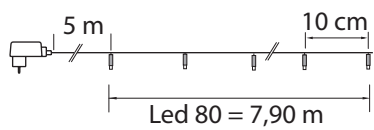
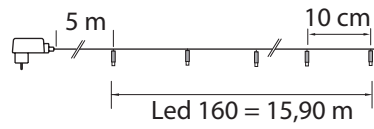
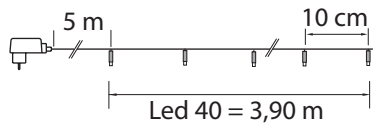
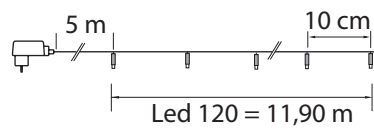
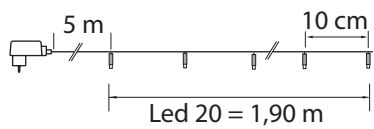



## LUNAR IP44

### LED-SARJA, SUPERKIRKAS

Huikaan häikäisevä LED-sarja monipuoliseen koristamiseen. Kaksi eri pituutta. LED kirkas, ei vaihdettava. Johto kirkas. Katso myös Lunar jääpuikkosarja sivulta 181.

### LED-SLINGA, MYCKET KLAR

Bländande klar LED-slinga för mångsidiga dekorationsändamål. Två olika längder. Klara LED-lampor, ej utbytbara. Genomskinlig sladd. Se även LED-slingan Lunar med istappar på sidan 181.

### LED SET, SUPER BRIGHT

An astonishingly bright set of LEDs for versatile decoration. Available in two lengths. LED clear, non-replaceable. Clear cord. Also see Lunar icicle light set on page 181.

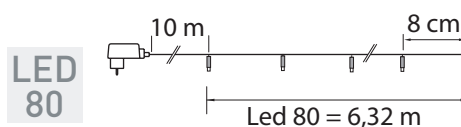

LED 80, 6,32 m

Nr 9478006

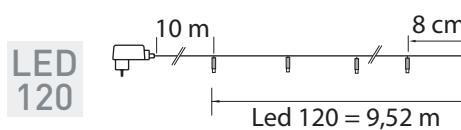

LED 120, 9,52 m

Nr 9478007





## VISIO IP44

### FLASHLIGHT LED-SARJA

LED-sarja, jossa joka kuudes (6.) LED vilkkuu (flashlight). LED lämmin keltainen, ei vaihdettava, kytketty 10 LEDin sarjaan. Johto tumma.

### LED-SLINGA FLASHLIGHT

LED-slinga där var sjätte lampa blinkar. Varmgula LED-lampor, ej utbytbara, kopplade i serie om tio lampor. Mörk sladd.

### FLASHLIGHT LED CHAIN

An LED set, where every sixth (6th) LED flashes. LED warm yellow, non-replaceable, connected with 10 LEDs in a series. Dark cord.

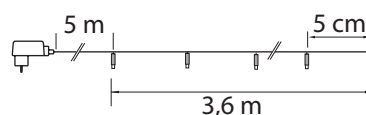

Nr 9477006



6 435200 193186



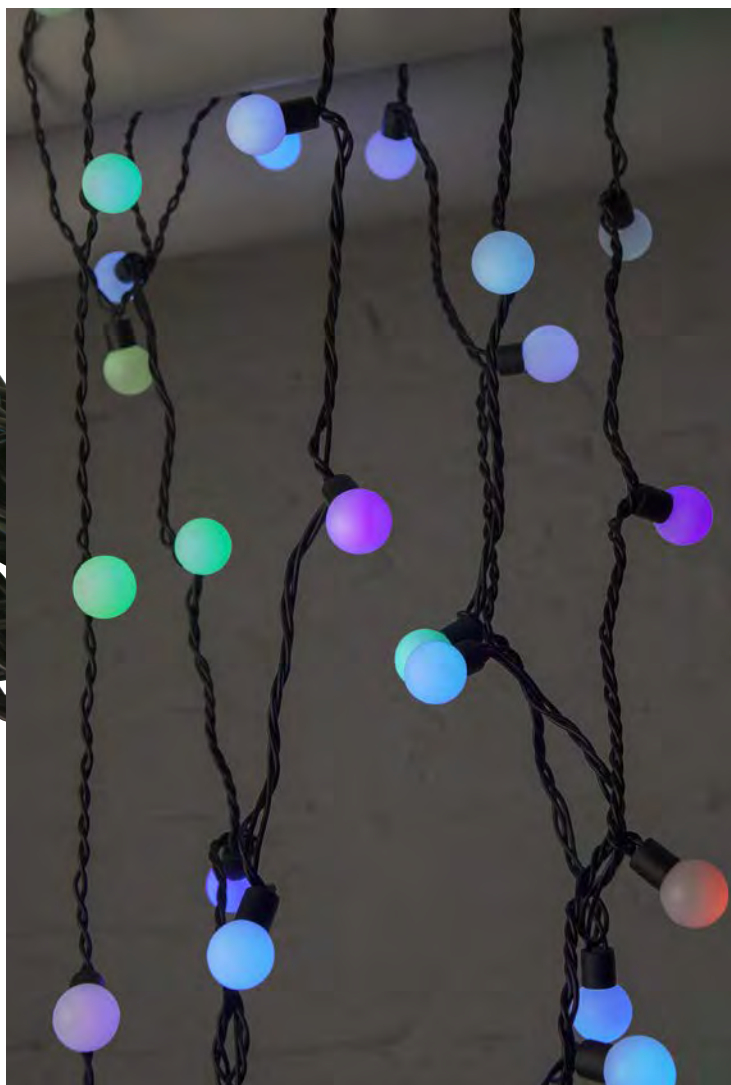

## TAIGA IP44

### RGB LED-PALLOSARJA

Automaattisesti väriävaihtava LED herkullisin värein hehkuvilla pienillä pallokuvuilla. LED väriävaihtava, ei vaihdettava. Johto musta.

### LED-BOLLSLINGA MED RGB-FUNKTION

LED-slinga med lampor som automatiskt skiftar färg och har små kupor som lyser i läckra färger. Färgskiftande LED-lampor, ej utbytbara. Svart sladd.

### RGB LED SPHERE SET

LEDs that automatically change colour, with delightfully glowing small sphere domes. LED colour-changing, non-replaceable. Black cord.

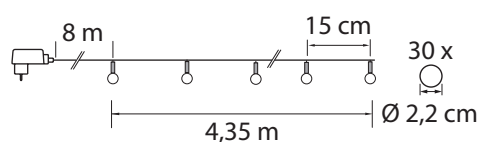

Nr 9478005





## ICE IP44

### LED-TÄHTISARJAT

Monipuolinen LED-sarja kirkkailla koristetähdillä. Kaksi eri pituutta. LED lämmin valkoinen, ei vaihdettava, kytketty 10 LEDin sarjaan. Johto kirkas.

### LED-LJUSSLINGA MED STJÄRNOR

Mångsidig LED-ljusslinga med genomskinliga dekorationsstjärnor. Tillgänglig i två olika längder. Varmvita LED-lampor, ej utbytbara, kopplade i serie om tio lampor. Genomskinlig sladd.

### LED LIGHT CHAINS WITH STARS

A versatile LED set with clear, decorative stars. Two different lengths. LED warm white, non-replaceable, connected with 10 LEDs in a series. Clear cord.

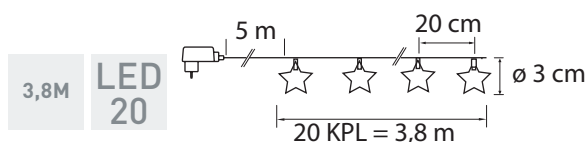

3,8M

LED  
20

20 led, 3,8 m

Nr 9477645



6 435200 148155



6

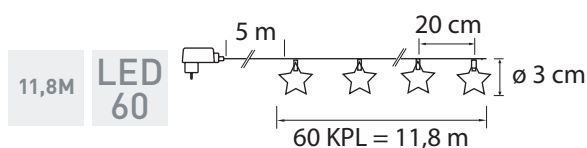

11,8M

LED  
60

60 led, 11,8 m

Nr 9477646



6 435200 148179



6



## TENO IP44

### LED-SARJAT

Valosarja saatavissa kahdessa eri pituudessa: 15 m sekä huomattavasti pidempi 30 m, joilla luot näyttäviä pihakoristeluja. LED lämmin keltainen, ei vaihdettava, kytketty 100 LEDin sarjaan. Johto musta.

### LED-SLINGOR

Ljusslingan finns i två olika längder: 15 m samt den hela 30 m långa. Med dem kan du skapa imponerande dekorationer utomhus. Varmvita LED-lampor, ej utbytbara, kopplade i serie om 100 lampor. Svart sladd.

### LED CHAINS

The light chain is available in two different lengths: 15 m and also the extremely long 30 m chain with which you can create impressive garden decorations. LED warm yellow, non-replaceable, connected with 100 LEDs in a series. Black cord.

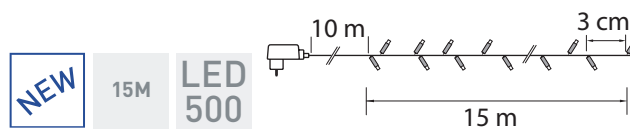

**NEW** 15M LED 500

500 led, 15 m

Nr 9478570



6 435200 247780



6

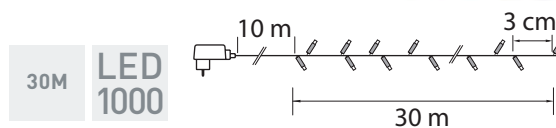

30M LED 1000

1000 led, 30 m

Nr 9476066



6 435200 207845



4





## IRTOJOHTO IP44

Lisäjohdon avulla voit ulottaa valosarjan haluamaasi kohteeseen. Johtoja voi liittää useita peräkkäin. Ei sisällä muuntajaa. Sopii eri LED-sarjoihin, tarkista kiinnikkeen sopivuus haluamaasi sarjaan. Pituus 10 m. Johto kirkas tai tumma.

### SKARVSLADD

Med skarvsladden kan du ha ljusslingan var du vill. Du kan koppla ihop flera sladdar. Transformator ingår ej. Passar i olika LED-slingor - kolla om fästet passar i slingan du väljer. Längd 10 m. Genomskinlig eller mörk sladd.

### EXTENSION CORD

With the extension cord, you can place the light chain wherever you like. You can join several cords together. No transformer included. Suitable for different LED chains - check if the fastener is right for the chain you choose. Length 10 m. Clear or dark cord.

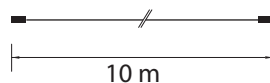

Tumma/ Mörk/ Dark

Nr 9478548



6 435200 247704



Kirkas/ Genomskinlig/  
Clear

Nr 9478547



6 435200 247681



A warm and inviting interior scene. A string of warm white lights is draped across the frame, illuminating a white shiplap wall. To the left, a woven tapestry with a geometric pattern hangs from a wooden frame. In the foreground, a wicker chair with a colorful, patterned cushion is visible. The overall atmosphere is cozy and bohemian.

LAMPPUSARJAT

Lampslinger  
Light Sets





#### ULKOVALOT KERTO VAT KODIN ASUKKAISTA.

Airam in lamppusarjoilla jatk at kodin sisustustyyliä tai juhlien teemaa myös ulkona. Koristele piha, parveke ja terassi juhlapäivää varten tai nauti persoonallisista ulkovaloista vuoden jokaisena päivänä. Erilaisia malleja löytyy runsaasti.

#### UTOMHUSLAMPOR BERÄTTAR OM DEM SOM BOR I Huset.

Med Airam s ljusslingor syns hemmets inredningsstil eller festens tema även från utsidan. Dekorera gården, balkongen och terrassen för en högtid eller njut av personliga utomhuslampor varje dag, året om. Vi har rikligt med olika modeller.

#### OUTDOOR LIGHTS TELL STORIES ABOUT THOSE WHO LIVE IN THE HOUSE.

With Airam's light chains, you make the style of your interior design visible to people passing by. Decorate your garden, balcony and terrace for a celebration, or enjoy your individual outdoor lights every day of the year. We have lots of different models.

**NEW**

IP44

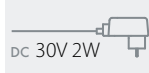
LED  
1010 000  
H

## NASHUA IP44

### LAMPPUSARJA

Sisä- ja ulkokäyttöön soveltuva Nashua korvaa perinteisen Bile-sarjan. Lamppujen sisältä näkyvä filamentti luo kokonaisuudesta kevyen ja raikkaan. Monikäyttöisellä lamppusarjalla piristät sekä arkea että juhlaa. Lamppukuviissa kaksi eri sävyvaihtoehtoa. LED lämmin valkoinen, ei vaihdettava. Johto tumma.

### LJUSSLINGA

Nashua som lämpar sig både för inom- och utomhusbruk ersätter Airam's traditionella Bile-serien. Synliga filamentstavar ger ett stämningsfullt ljus. En mångsidigt och användbar lamperie för både vardag och fest. Kuporna finns i två olika färgtoner. LED varmvit, ej utbytbar. Sladden är mörk.

### LAMP SET

Suitable for in- and outdoor use, the Nashua set replaces the traditional Bile set. The filament visible in the lamps makes the set light and fresh. A versatile lamp set to brighten up any occasion. The globes come in two different shades. LED warm white, non-replaceable. The cord is dark.

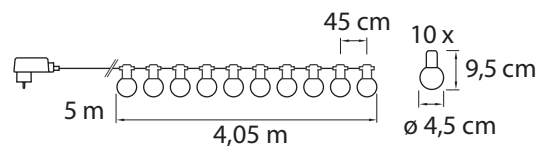
Nashua  
Kirkas/ Klar/ Clear

Nr 9478517



6 435200 246851



6



Värmix/ Färgmix/ Colour mix

Nr 9478518



6 435200 246875



6





## NEPTUS IP44

### KYNTTILÄLAMPPUSARJA

Neptus -lamppusarjan kirkkaissa kynttilälampuissa on kaunis kierrekuvio. LED-sarja soveltuu sekä sisä- että ulkokäyttöön ja sillä voi koristella vaikka pihan koristepuun tai luoda tunnelmaa terassille. LED lämmin valkoinen, ei vaihdettava. Johto tumma.

### KRONLJUS-SLINGA

De klara kronljuslamporna i ljusslingan Neptus har ett vackert spiralmönster. LED-serien lämpar sig både för inom- och utomhusbruk, och kan hängas både i trädgården och på terrassen. LED varmvit, ej utbytbar. Sladden är mörk.

### CANDLE LAMP SET

The clear candle lamps in the Neptus lamp set have a beautiful spiral pattern. The LED set is ideal for both in- and outdoor use. It can be used for decorating an ornamental tree or creating an atmosphere on the terrace. LED warm white, non-replaceable. The cord is dark.

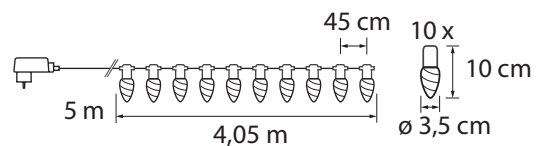

Neptus

Nr 9478516



6 435200 244895



6



## KEIRA IP44

### LED-LAMPPUSARJA

Ilmeikäs lamppusarja kirkkailla lampuilla ja mustavalkoisella kangasjohdolla. LED lämmin valkoinen, ei vaihdettava.

### LED-LAMPSLINGA

Uttrycksfull lampslinga med genomskinliga lampor och svartvit tygsladd. Varmvita LED-lampor, ej utbytbara.

### LED LAMP SET

An expressive set of lamps with a decorative black-and-white fabric cord. LED warm white, non-replaceable.



Mustavalkoinen kangasjohto.  
Svartvit tygslagg.  
Black-and-white fabric cord.

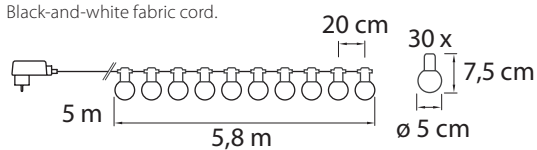

Nr 9477979





## KAJO IP44

### LED-LAMPPUSARJA

Kaunis lamppusarja vaihdettavilla E27-kantaisilla lampuilla, 0,5W. LED lämmin valkoinen, vaihdettava. Varalampun nro 9477322. Soveltuu vain Kajo -sarjaan. Materiaali muovi, lamppu lasia. Johto valkoinen.

### LED-LAMPSLINGA

Vacker lampslinga med utbytbara lampor med E27-sockel, 0,5 W. Varmvita LED-lampor, utbytbara. Reservlampans nr 9477322. Passar endast för ljusslingan Kajo. Material: plast, lampor av glas. Vit sladd.

### LED LAMP SET

A beautiful set of lights with replaceable E27 0.5 W bulbs. LED warm white, replaceable. Spare LEDs no. 9477322. Material: plastic, glass lamps. White cord.

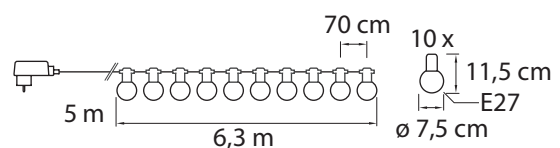

Nr 9477819



6

Varalamppu/ Sparlampa/  
Spare bulb 0,5W E27

Nr 9477322



5



**NEW**

IP44

LED  
4010 000  
H

DC 31V 3,6W



## PECOS IP44

### KORISTELAMPPUSARJA

Sisä- ja ulkokäyttöön tarkoitettu valosarja, jossa sirot pienet lamput. Voidaan asetella erilaisiin koristelukohteisiin. LED lämmin valkoinen, ei vaihdettava. Materiaali muovi. Johto kirkas.

### DEKORATIONSLAMPSLINGA

En ljusslinga med sirliga små lampor. För inom- och utomhusbruk. Kan placeras på olika ställen som ska dekoreras. Varmvita LED-lampor, ej utbytbara. Material: plast. Genomskinlig sladd.

### DECORATIVE LAMP SET

A light set with small, slender lamps. For in- and outdoor use. Can be arranged in places to be decorated. LED warm white, non-replaceable. Material: plastic. Clear cord.

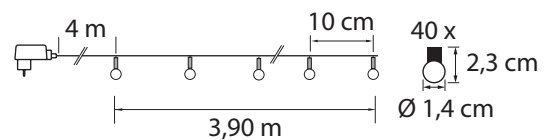

Nr 9478523





## AVON IP44

### LED-LAMPPUSARJA

Valkoinen lamppusarja antaa kauniin pehmeän valokajon. LED lämmin valkoinen, ei vaihdettava, rinnankytketty. Materiaali muovi. Johto valkoinen.

### LED-LAMPSLINGA

Vit lamplingsa som avger ett vackert mjukt ljussken. Varmvita LED-lampor, ej utbytbara, parallellkopplade. Material: plast. Vit sladd.

### LED LAMP SET

A set of white lamps that provide a beautiful soft shimmer. LED warm white, non-replaceable, parallel connection. Material: plastic. White cord.

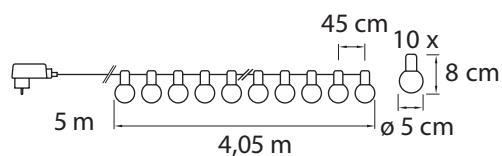

Nr 9477944



**NEW**

IP44

LED  
1010 000  
H

dc 3,5V 2,5W



## NORTE IP44

### LAMPPUSARJA

Norte lamppusarjalla luot näyttäviä kokonaisuuksia sekä sisälle että ulos. Litteä johto luo valosarjaan oman ilmeensä ja on myös ripustettaessa tukeva ja helppo asetella. LED lämmin valkoinen, ei vaihdettava. Johto musta.

### LJUSSLINGA

Med slingan Norte skapar du kreativa upphängningar både inom och utomhus. Den platta sladden ger slingan en egen karaktär och är även stadig vid upphängning och lätt att placera. LED varmvit, ej utbytbar. Sladden är svart.

### LAMP SET

With the Norte lamp set, you can create impressive ornamentations both in- and outdoors. The flat cord gives the lamp set a special look, it is steady while hanging and easy to arrange. LED warm white, non-replaceable. The cord is black.

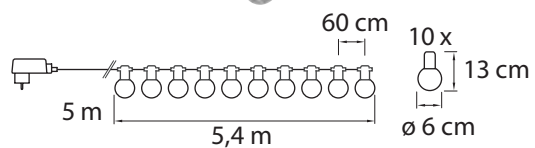

Nr 9478515







## HUVI IP44

### LED-LAMPPUSARJA

Näyttävä industrial-henkinen lamppusarja. Klipsikiinnitys lampun kannassa. LED lämmin valkoinen, ei vaihdettava. Materiaali muovi ja metalli. Johto musta.

### LED-LAMPSLINGA

Spännande, industriliknande lampslinga. Klämfäste vid lampans sockel. Varmvita LED-lampor, ej utbytbara. Material: plast och metall. Svart sladd.

### LED LAMP SET

An impressive industrial-style set of lamps. Clip attachment in the base of the lamp. LED warm white, non-replaceable. Material: metal and plastic. Black cord.

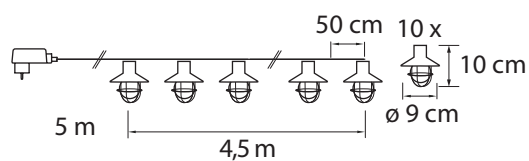

Nr 9477941



6 435200 220301



4



## TALLILYHTY IP44

### LED-LYHTY

Klassinen antiikkimusta tallilyhty, jossa irroitettava lyhtysuojus. Pienet kiinnityskoukut. LED 10 kpl lämmin valkoinen, ei vaihdettava. Materiaali metalli ja muovi. Johto musta.

### LED-OLJELYKTA

Klassisk, antiksvart oljelykta med avtagbart hölje och små fästkrokar. Varmvita LED-lampor, ej utbytbara. Material: metall och plast. Svart sladd.

### LED LANTERN

A classic black antique lantern with a removable cover. Small attachment hooks. LED warm white, non-replaceable. Material: metal and plastic. Black cord.

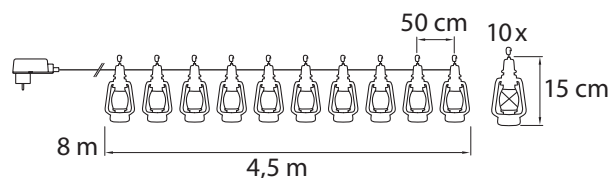

Nr 9476729



**NEW**

IP44



LED

WARM  
WHITE10 000  
H

6h TIMER

4x AA

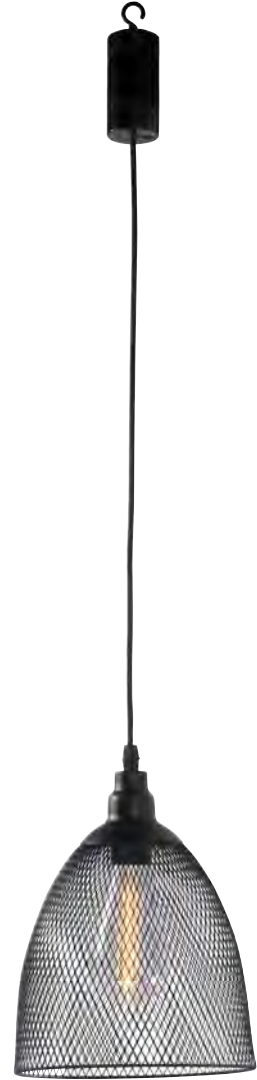

## PARIS IP44

### KORISTEVALO

Kaunis koristevalaisin, jossa on ulkokäyttöön soveltuva, vesiroiskeilta suojattu paristokotelo. Luo tunnelmaa esim. parvekkeelle tai kuistille. Ei vaadi sähköjohtoja ja on helppo ripustaa. Mallisuojattu lamppu. LED lämmin valkoinen, ei vaihdettava. Sisältää paristot ja ajastimen. Materiaali metalli ja muovi. On/off- ja ajastinkytkin.

### DEKORATIONS-LAMPA

En vacker dekorationslampa med ett batterifodral som lämpar sig för utomhusbruk och är skyddat mot vattenstänk. Skapar stämning t.ex. på balkongen eller verandan. Behöver inga sladdar. Lätt att hänga upp. En mönsterskyddad lampa. LED varmvit, ej utbytbar. Innehåller batterier och en timer. Tillverkad av metall och plast. Av-/på- och timerknapp.

### ORNAMENTAL LAMP

A beautiful ornamental lamp with a battery casing suitable for outdoor use and protected against splashes. Creates atmosphere e.g. in the balcony or on the porch. Needs no cords. Easy to hang up. A protected design. LED warm white, non-replaceable. Batteries and timer included. Made of metal and plastic. On/off and timer switch.

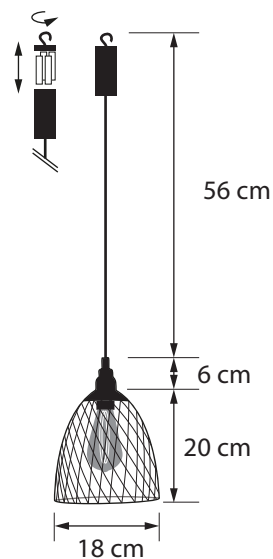

Nr 9478015



6 435200 237019



NARUKORISTEET

Repprodukter  
Products of Rope





### OHOI, VALOA NÄKYVISSÄ!

Airamien merihenkiset narukoristeet sopivat sekä sisälle että ulos. Valoa ja narua löytyy kaikista tuotteista, mutta muotoja, kokoja ja tapoja ripustaa on monia. Tuotteet sopivat myös maakravaille.

### LJUS, OHOJ!

Airam's maritima snördekorationer kan man ha både inom- och utomhus. Ljus och snören finns i alla produkterna, men det finns många former, storlekar och sätt att hänga upp. Produkterna kan även användas av landkrabbor.

### LIGHT, AHOY!

Airam's marine string decorations are suitable for both indoor and outdoor use. There are lights and strings in all our products, but there are also many shapes, sizes and suspensions. The products are also ideal for landlubbers.



## EIMI IP44

### LED-KORISTEPALLO

Ulosjoiottavalla paristokotelolla varustettu, merihenkinen LED-koristepallo köysinarusomistein. LED lämmin valkoinen, ei vaihdettava. Sisältää paristot. Materiaali muovi ja naru. Johto kirkas. On/off-kytkin.

### LED-DEKORATIONSBALL

Marininspirerad LED-dekorationsboll med batterifack för utomhusbruk. Dekorerad med rep. Varmvita LED-lampor, ej utbytbara. Batterier medföljer. Material: plast och rep. Genomskinlig sladd. Av/på-knapp.

### LED DECORATION BALL

A maritime LED decoration ball with a water-proof outdoor battery case. Rope string ornaments. LED warm white, non-replaceable. Batteries included. Material: plastic and rope. Clear cord. On/off switch.

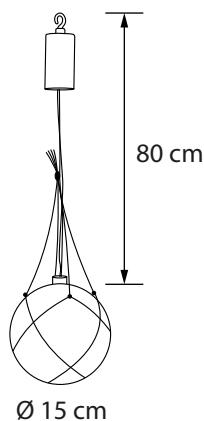

Nr 9477958





## RITA IP44

### LED-LAMPPU

Ulossijoitettavalla paristokotelolla varustettu LED-lamppu. Lamppu mallisuoja. LED lämmin keltainen, ei vaihdettava. Sisältää paristot. Materiaali muovi ja köysinaru.

### LED-LAMPA

LED-lampa med batterifack för utomhusbruk. Formskyddad design. Varmgul LED-lampa, ej utbytbar. Batterier medföljer. Material: plast och rep.

### LED LAMP

A LED lamp with a water-proof outdoor battery case. The lamp is a protected design. LED warm yellow, non-replaceable. Batteries included. Material: plastic and rope.

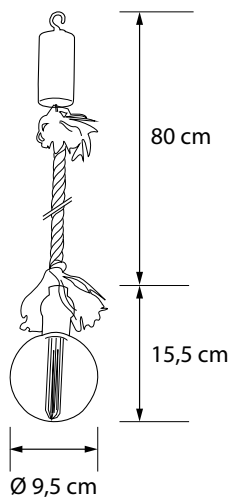

Nr 9476647





## GEN IP44

### LED-KÖYSI

Pitkä köysi, jossa tiheästi LED-valoja. Kieputa näyttävään asetelmaan esim. pylvään ympärille. LED lämmin valkoinen, ei vaihdettava. Johto kirkas.

### LED-REP

Långt rep med många LED-lampor. Kan lindas och knytas till kreativa arrangemang, t.ex. runt en pelare. Varmvita LED-lampor, ej utbytbara. Genomskinlig sladd.

### LED ROPE

A long rope with lots of interlaced LED lights. Twirl into an impressive arrangement, e.g. around a pillar. LED warm white, non-replaceable. Clear cord.

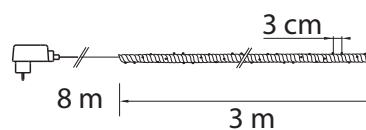

Nr 9477960







## PALOMA IP44

### LED-NARUVERKKO

Ulosjoiottavalla paristokotelolla varustettu naruverkko, jonka valaisee ohut valolankasarja. Kaunis ja ilmeikäs esim. parvekkeelle levitettyinä. LED lämmin valkoinen, ei vaihdettava. Sisältää paristot. Johto kirkas. On/Off-kytkin.

### LED-NÄT

Ett nät av snören som lysas upp av en tunn ljusslinga och med batterifack för utomhusbruk. Vacker och uttrycksfull dekoration t.ex. för terrassen. Varmvita LED-lampor, ej utbytbara. Batterier ingår. Genomskinlig sladd. Av/på-knapp.

### LED STRING NET

A string net lit up by a set of thin light threads. Water-proof outdoor battery case. Beautiful and expressive, for example, spread out on a balcony. LED warm white, non-replaceable. Batteries included. Clear cord. On/off switch.

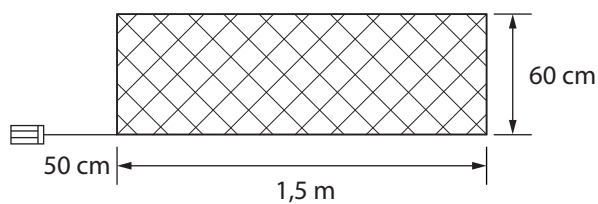

Nr 9477959



JÄÄPUIKOT, VERHOT,  
LATVASARJAT, VERKOT (IP44)

Istappar, gardiner, toppslingor, nät (IP44)  
Icicles, Curtains, Tree top sets, Nets (IP44)





#### LUO LOISTAVA VERKOSTO IHAN HETKESSÄ.

Verkkoja, puikkoja, latvasarjoja, hiutaleita. Ulkokäyttöön soveltuvista led-koristevalosarjoista löytyy monenlaisia muotoja ja rakenteita. Jo yksittäisellä sarjalla loihdit ilmettä pihapiiriin ja tuotteita yhdistelemällä saat helposti pihalle paljon valoa.

#### SKAPA ETT FINT NÄTVERK SNABBT.

Nät, pinnar, toppslingor, snöflingor. Bland de dekorativa LED-ljusslingor som lämpar sig för utomhusbruk har vi många olika former och konstruktioner. Med bara en enda slinga kan du trolla fram en fin stämning utomhus, och genom att kombinera olika produkter får du lätt mycket ljus i trädgården.

#### CREATE A SPLENDID NETWORK IN NO TIME.

Nets, rods, treetop chains, snowflakes. Among our decorative LED chains for outdoor use, there are many different shapes and constructions. Even with one single chain, you can conjure up a great atmosphere in your garden, and by combining different products, you'll get lots of light in your garden easily.

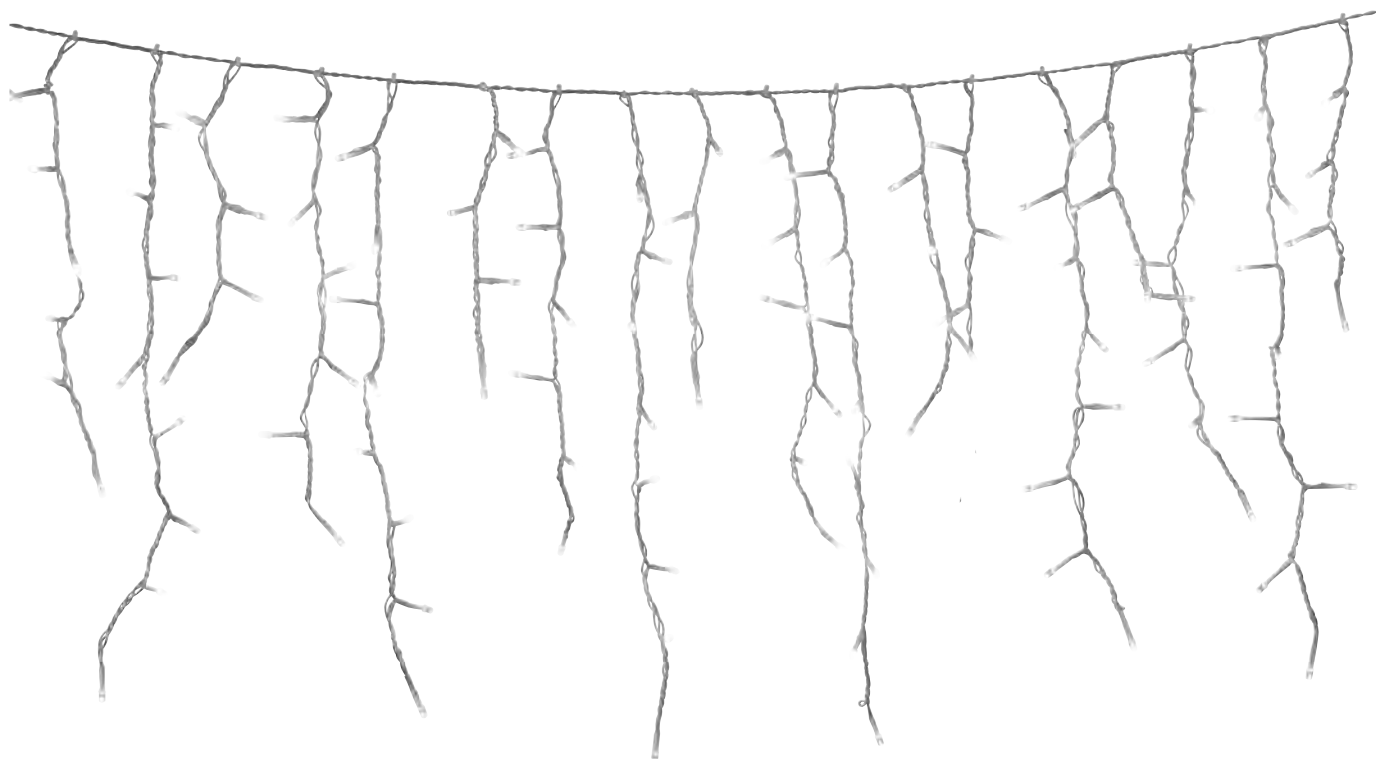

## KIIA IP44

### JÄÄPUIKKOSARJA

Jääpuikkosarja, jossa ketjut ovat erityisen tiheässä (48 ketjua). LED kirkas, ei vaihdettava. Materiaali muovi. Johto kirkas.

### SLINGA MED ISTAPPAR

Slings med istappar där de 48 kedjorna ligger speciellt tätt. Genomskinliga LED-lampor, ej utbytbara. Material: plast. Genomskinlig sladd.

### ICICLE LIGHT SET

An icicle light set in which the 48 chains are particularly close. LED clear, non-replaceable. Material: plastic. Clear cord.

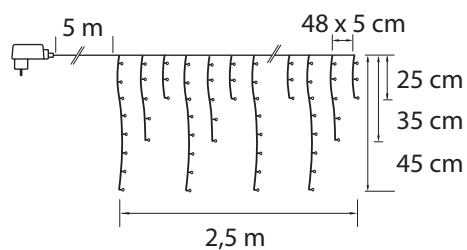

Nr 9478537





## LUNAR IP44

### JÄÄPUIKKOSARJA

Huikean kirkas (6500K) jääpuikkosarja. LED kirkas, ei vaihdettava. Johto kirkas. Katso myös Lunar IP44 LED-sarjat sivulta 154.

### LED-SLINGA MED ISTAPPAR

Otroligt klar (6500K) ljusslinga med istappar. Genomskinliga LED-lampor, ej utbytbara. Genomskinlig sladd. Se även LED-slingorna Lunar IP44 på sidan 154.

### ICICLE LIGHT SET

An astonishingly bright (6500K) set of icicle lights. LED clear, non-replaceable. Clear cord. Also see the Lunar IP44 LED sets on page 154.

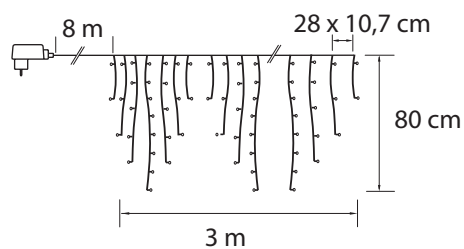

Nr 9478008





IP44 1,2M LED 72 WARM WHITE 10 000 H

dc 31V 3,6W

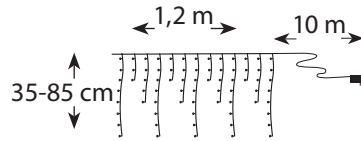

1,2 m (72 LED):  
13 ketjua/ kedjor/ chains

Nr 9476630



IP44 2,5M LED 100 WARM WHITE 10 000 H

dc 31V 3,6VA

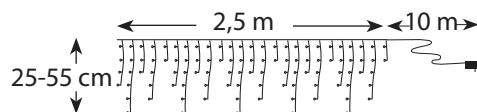

2,5 m (100 LED):  
25 ketjua/ kedjor/ chains

Nr 9476631



## LED JÄÄPUIKKOKETJUT IP44

Näyttävyyttä ikkunoihin, räystäsiin, kaiteisiin jne. Kolme eri kokovaihtoehtoa. Mukana 10 kpl nippusidekiinnikkeitä. LED lämmin valkoinen, ei vaihdettava, kytketty 8-10 LEDin sarjaan. Johto kirkas.

### LED-LJUSKEDJÖR MED ISTAPPAR IP44

Dekorera dina fönster, takfötter, räcken m.m. Finns i tre storlekar. 10 st. buntband medföljer. Varmvita LED-lampor, ej utbytbara, kopplade i serie om åtta till tio lampor. Genomskinlig sladd.

### LED ICICLE LIGHT CHAINS IP44

Make your windows, cornices, railings, etc. more impressive. Available in three different sizes. Comes with 10 cable ties for fastening. LED warm white, non-replaceable, connected with 8-10 LEDs in a series. Clear cord.

IP44 6,8M LED 140 WARM WHITE 10 000 H

dc 31V 6W

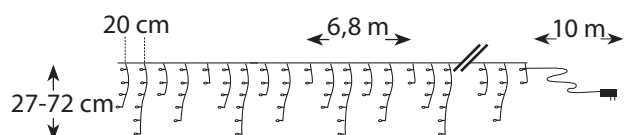

6,8 m (140 LED):  
35 ketjua/ kedjor/ chains

Nr 9477281





## VESTA 20 IP44

### LED-JÄÄPUIKKOKETJUT

20 jääpuikkoketjua, joista joka toinen ketju/jääpuikko korkeammalla. LED lämmin valkoinen, ei vaihdettava, kytketty 10 LEDin sarjaan. Johto kirkas.

### LED-KEDJOR MED ISTAPPAR

20 st. kedjor med istappar där varannan kedja/istapp är placerad högre upp. Varmvita LED-lampor, ej utbytbara, kopplade i serie om tio lampor. Genomskinlig sladd.

### LED ICICLE LIGHT CHAINS

A series of twenty icicles on chains, with every other icicle placed higher. LED warm white, non-replaceable, connected with 10 LEDs in a series. Clear cord.

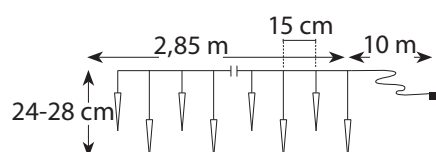

Nr 9476778





## VESTA 40 IP44

### LED-JÄÄPUIKKOKETJUT

40 jääpuikkoa tasakorkeudella. LED lämmin valkoinen, ei vaihdettava, kytketty 10 LEDin sarjaan. Johto kirkas.

### LED-KEDJOR MED ISTAPPAR

40 st. istappar på samma höjd. Varmvita LED-lampor, ej utbytbara, kopplade i serie om tio lampor. Genomsiktig sladd.

### LED ICICLE LIGHT CHAINS

Forty icicles at the same height. LED warm white, non-replaceable, connected with 10 LEDs in a series. Clear cord.

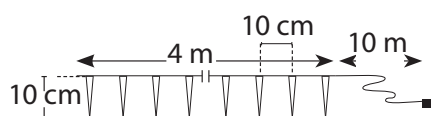

Nr 9476777



6 435200 141095



6



NEW

IP44



LED  
70



10 000  
H

DC 3,2V 1,92W



## TRINITY IP44

### HIUTALEVERHO

Kaunis hiutaleverho, jossa eri korkeuksilla roikkuvia hiutalekoristeita. LED 70 kpl: 10 kpl/ hiutale, kirkas, ei vaihdettava. Materiaali muovi. Johto kirkas.

### GARDIN MED SNÖFLINGOR

En vacker gardin med dekorativa snöflingor hängande i olika höjder. LED 70 st.: 10 st./ snöflinga, genomskinliga, ej utbytbara. Material: plast. Genomskinlig sladd.

### SNOWFLAKE CURTAIN

A beautiful curtain with snowflake decorations hanging at different heights. 70 LEDs: 10 LEDs/ snowflake, clear, non-replaceable. Material: plastic. Clear cord.

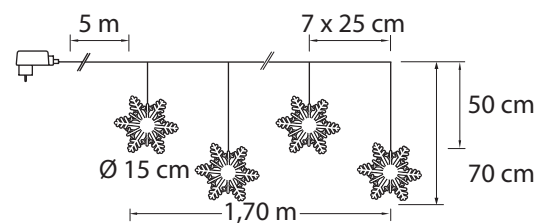

Nr 9478538



6



## TELMA IP44

### LED-JÄÄKIDEVERHO

8 kpl verhomaisesti eri korkeuksilla roikkuvia jääkiteitä. LED lämmin valkoinen, ei vaihdettava, rinnankytketty. Johto kirkas.

### LED-GARDIN MED ISKRISTALLER

8 st. iskristaller som hänger på olika höjd på ett gardinliknande sätt. Varmvita LED-lampor, ej utbytbara, parallellkopplade. Genomskinlig sladd.

### LED ICE CRYSTAL CHAIN

Eight ice crystals hanging at different heights in a curtain-like fashion. LED warm white, non-replaceable, parallel connection. Clear cord.

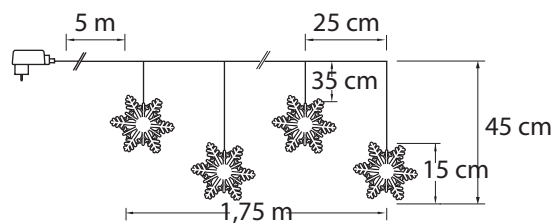

Nr 9476757



6 435200 193285



6



## KAILI IP44

### LED-TÄHTIVERHO

Näyttävä esim. räystäslaudassa, kaiteessa tai ikkunassa. LED lämmin valkoinen, ei vaihdettava, kytketty 10 LEDin sarjaan. Ketjut 5 kpl. Johto kirkas.

### LED-STJÄRNGARDIN

Snygg dekoration för t.ex. takfötter, räcken eller fönster. Varmvita LED-lampor, ej utbytbara, kopplade i serie om tio lampor. 5 st. kedjor. Genomskinlig sladd.

### LED STAR CURTAIN

Provides an impressive look on eaves, railings or windows, for example. LED warm white, non-replaceable, connected with 10 LEDs in a series. Chains 5 pcs. Clear cord.

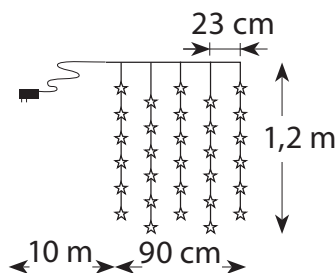

Nr 9477652



**NEW**

IP44

LED  
16010 000  
H

DC 4,5V 1,2W



## ESTERO IP44

### VALOKORISTE

Ryhmä tukevia LED-valolankoja, jotka voi taivutella yksitellen esim. pallomaiseen muotoon. Luo erityisen näyttävä kokonaisuus asettelemalla useita koristeita eri korkeuksille. LED lämmin valkoinen, ei vaihdettava. Johto kirkas.

### LJUSDEKORATION

En grupp kraftiga LED-trådslingor som kan böjas en och en t.ex. till en boll. Du kan skapa en speciellt imponerande helhet genom att placera flera dekorationer i olika höjder. Varmvita LED-lampor, ej utbytbara. Genomskinlig sladd.

### LIGHT DECORATION

A group of solid LED light wires that you can bend one by one to form e.g. a ball. Create a highly impressive decoration by arranging several decorations at different heights. LED warm white, non-replaceable. Clear cord.

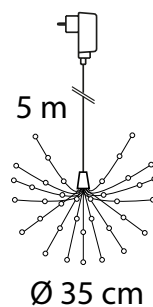

Nr 9478558



6 435200 249913



12



## RIONI IP44

### LED-LATVASARJA

Monikäyttöisen tähtiverhon voi mm. kiepauttaa latvakoristeeksi tai asetella kehikkoihin tai lyhtyjen koristeeksi. LED 90 kpl: 15 kpl/ ketju, lämmin valkoinen, ei vaihdettava. Materiaali metalli ja muovi. Ketjuissa tähtikoristeet. Johto kirkas.

### LED-TOPPSLINGA

Mångsidigt ljusnät med stjärnor som bl.a. kan användas som julgransdekoration, viras runt olika stommar eller användas som dekoration i lyktor. 90 st varmvita LED-lampor (15 st./kedja), ej utbytbara. Material: metall och plast. Slingorna har stjärndekorationer. Genomskinlig sladd.

### LED TREETOP SET

The versatile star-light decoration can be wrapped around the top of a Christmas tree or used to adorn frames or lanterns. LED 90 pcs: 15 pcs/ chain, warm white, non-replaceable. Material: metal and plastic. Star decorations on the chains. Clear cord.

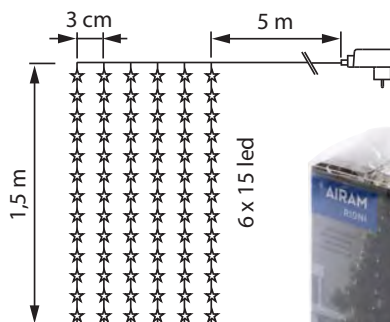

Nr 9478021





## CAIRO IP44

### LED-LATVASARJA

Latvasarjalla koristelet pihapuut helposti. Kiinnitystapansa ansiosta soveltuu myös esim. korkeiden seinäpintojen verhoamiseen. LED 240 kpl: 30 kpl/ketju, lämmin valkoinen, ei vaihdettava, rinnankytketty. Johto musta.

### LED-TOPPSLINGA

Med en toppslinga dekorerar du enkelt gårdens träd. Tack vare fastsättningen lämpar den sig t.ex. för dekoration av höga väggtytor. 240 st. varmvita LED-lampor (30 st./slinga), ej utbytbara, parallellkopplade. Svart sladd.

### LED TREETOP SET

The treetop set can be used to easily decorate the trees in the garden. Due to the attachment method, the product is also suitable for decorating tall wall surfaces. LED 240 pcs: 30 pcs/chain, warm white, non-replaceable, parallel connection. Black cord.

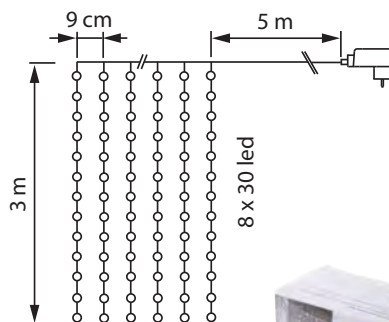

Nr 9478009





IP44			7M	LED 360	WARM YELLOW	10 000 H

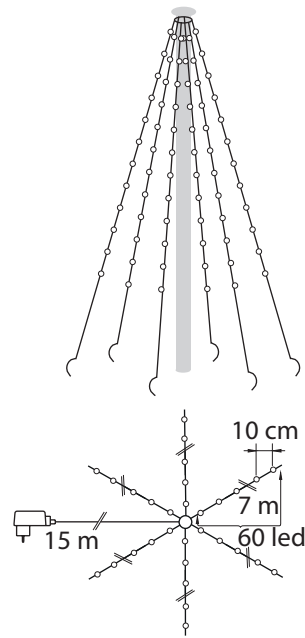

7 m (360 LED):  
6 ketjua/ kedjor/ chains

Nr 9476644

6 435200 193322



## EIFFEL IP44

### LED-LATVASARJAT

Puiden, kehikoiden tai lipputangon koristamiseen sopiva LED-sarja. Mukana latvaan kiinnitettävä rinkula, maapiikit sekä lenkki lipputankoon nostoa varten. Kaksi eri kokovaihtoehtoa. LED lämmin keltainen, ei vaihdettava, kytketty 10 LEDin sarjaan. Johto tumma.

### LED-TOPPSLINGOR

LED-slingor som lämpar sig för dekoration av träd, olika stommar eller flaggstången. En ring som ska fästas i toppen, piggar att fästa i marken samt en ögla för att hissa upp ljusslingorna i flaggstången medföljer. Finns i två storlekar. Varmgula LED-lampor, ej utbytbara, kopplade i serie om tio lampor. Mörk sladd.

### LED FLAGPOLE SET

An LED set suited for decorating trees, flagpoles or various structures for example. Comes with a ring that is attached to the top, ground spikes and a loop for hoisting the set up a flagpole. Available in two different sizes. LED warm yellow, non-replaceable, connected with 10 LEDs in a series. Dark cord.

IP44			9M	LED 360	WARM YELLOW	10 000 H

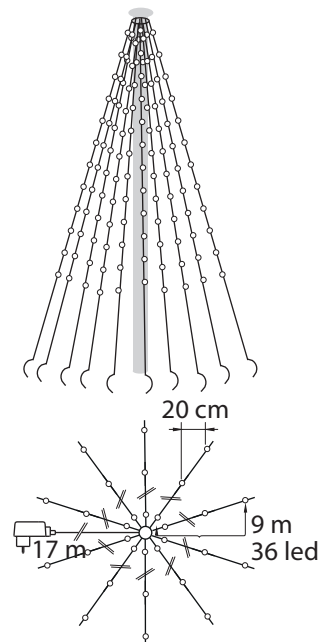

9 m (360 LED):  
10 ketjua/ kedjor/ chains

Nr 9477036

6 435200 200846





## KULMA IP44

### LED-VERKKO

Uudenlainen kolmionmuotoinen LED-verkko, joka voidaan asentaa sisenevään tai ulkonevaan kulmaan tai kehikon ympärille. Verkosta voi muodostaa seinälle myös taatusti allergiaystävällisen joulukuusen! LED lämmin valkoinen, ei vaihdettava, rinnankytketty. Materiaali muovi. Johto kirkas.

### LED-NÄT

Nytt, triangelformat LED-nät som kan monteras i inåtgående eller utåtgående hörn, eller runt en stomme. Av nätet kan man även skapa en garanterat allergivänlig julgran på väggen! Varmvita LED-lampor, ej utbytbara, parallellkopplade. Material: plast. Genomskinlig sladd.



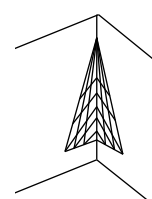
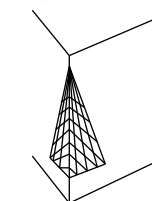
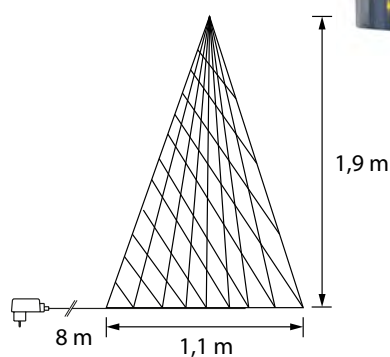

### LED NET

A novel triangular LED net that can be installed in an inward or outward corner or around a frame. The net can also be arranged on the wall in the shape of a Christmas tree that is guaranteed to be non-allergenic! LED warm white, non-replaceable, parallel connection. Material: plastic, Clear cord.

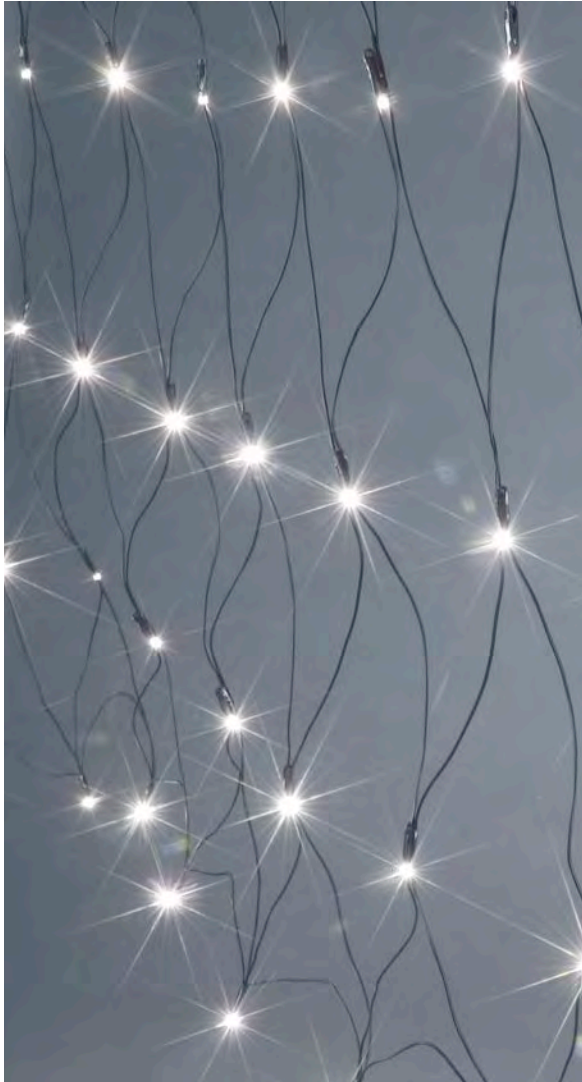





IP44   2x1,5M **LED 104**  WARM WHITE 10 000 H  
 DC 31V 3,6W 

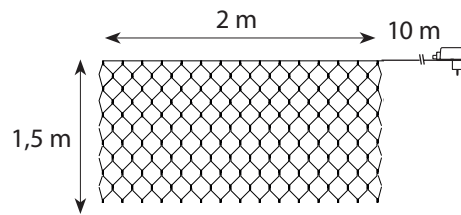

2 m x 1,5 m, 104 LED

Nr 9476627



## LED-VERKOT IP44





LED-verkot, kaksi eri kokoa. Mukana 10 kpl nippusidekiinnikkeitä. LED lämmin valkoinen, ei vaihdettava, kytketty 10 LEDin sarjaan. Johto vihreä.

### LED-NÄT IP44

LED-nät, två olika storlekar. 10 st. buntband medföljer. Varmvita LED-lampor, ej utbytbara, kopplade i serie om tio lampor. Grön sladd.

### LED NETS IP44

LED nets, two different sizes. Comes with 10 cable ties for fastening. LED warm white, non-replaceable, connected with 10 LEDs in a series. Green cord.

IP44   3x3M **LED 180**  WARM WHITE 10 000 H  
 DC 31V 6W 

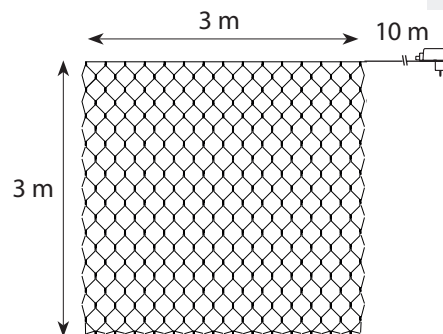

3 m x 3 m, 180 LED

Nr 9476629



## JATKETTAVAT VALOSARJAT (IP44)

Förlängbara ljusslingor (IP44)  
Connectable LED Sets (IP44)

### VALO EI LOPU KESKEN.

Airamien jatkettavilla valosarjoilla puetaan suuremman talon juhla-asuun. Valosarjoja on erilaisia ja ne on helppo liittää toisiinsa. Anna talosi loistaa.

### LJUSET TARINTE SLUT.

Med Airams förlängbara ljusslingor klär du även ett stort hus i festskrud. Det finns olika sorters ljusslingor och de är lätta att koppla ihop med varandra. Låt ditt hus stråla.

### A LIGHT THAT NEVER GOES OUT.

The extendable light sets by Airam can be used to dress even the largest houses for festive occasions. The versatile range includes plenty of sets that can be easily connected with each other. Let your house shine bright.

# VALOMAA IP44

## JATKETTAVA LED-SARJA

Valomaa-kokonaisuuteen kuuluu seitsemän erilaista osaa, jotka kaikki voidaan kytkeä suoraan muuntajaan. Yhteen muuntajaan voi liittää maks. 100 m pitkän kokonaisuuden tai 1000 LEDiä (maks. teho yht. 60 W). Valomaa-sarjaa ei saa kytkeä sekaisin muiden jatkettavien valosarjojen kanssa. Kaikki osat myydään erikseen.

## FÖRLÄNGBAR LED-SLINGA

Valomaa-serien består av sju olika delar, som alla kan anslutas direkt till en transformator. Till en transformator kan högst en 100 meter lång slinga eller 1 000 LED-lampor anslutas (sammanlagd effekt högst 60 W). Valomaa-slingan får inte kopplas till andra förlängbara lampslingor. Alla delar säljs separat.

## AN EXTENDABLE LED SET

The Valomaa (Land of Light) system consists of seven separate parts that can be directly connected to a transformer. One transformer can be connected to a set of lights that is max. 100 m long or has 1,000 LEDs (with total max. power of 60 W). The Valomaa set must not be connected or mixed with other extendable light series. All parts are sold separately.

### OSA 1

Perusosa  
Muuntaja

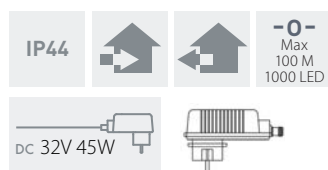

### DEL 1

Basdel  
Transformator

Osa/ Del/ Part 1

Nr 9477655



### PART 1

Basic unit  
Transformer

### OSA 2

Lisätarvike  
Liitosjohto 5 m

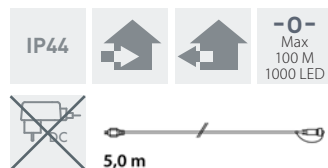

### DEL 2

Tillbehör  
Anslutningskabel 5 m

Osa/ Del/ Part 2

Kirkas/ Klar/ Clear

Nr 9477656



### PART 2

Accessory  
Connecting wire 5 m

Osa/ Del/ Part 2

Musta/ Svart/ Black

Nr 9477731



### OSA 3

Lisätarvike  
Haarotusjohto 0,5 m

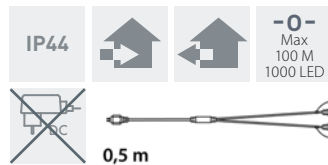

### DEL 3

Tillbehör  
Förgreningskabel 0,5 m

Osa/ Del/ Part 3

Kirkas/ Klar/ Clear

Nr 9477657



### PART 3

Accessory  
Branching wire 0.5 m

Osa/ Del/ Part 3

Musta/ Svart/ Black

Nr 9477732



### OSA 4

Led-lisäsarja 5 m  
Valo-osan pituus 5 m, LEDien väli 10 cm.  
LED lämmin valkoinen, ei vaihdettava,  
kytketty 10 LEDin sarjaan. Johto musta  
tai kirkas.

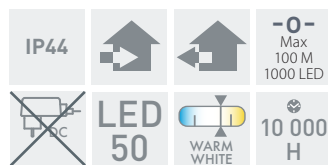

### DEL 4

LED-tilläggslinga 5 m  
Längd på den kabeldel som har lampor: 5 m.  
Avstånd mellan lamporna: 10 cm. Varmvita  
LED-lampor, ej utbytbara, kopplade i serie  
om tio lampor. Svart eller genomskinlig sladd.

Osa/ Del/ Part 4

Kirkas/ Klar/ Clear

Nr 9477658



### PART 4

Additional LED set 5 m  
Length of the light unit 5 m, LEDs placed  
at 10 cm intervals. LED warm white,  
non-replaceable, connected with 10 LEDs  
in a series. Black or clear cord.



5,0 m

### OSA 5

LED jääpuikkolisäsarja 2,6 m  
Valo-osan pituus 2,6 m, ketjuja 25 kpl,  
ketjujen korkeus 20-50 cm. LEDien väli 10  
cm. LED 100 kpl: 2 - 5 kpl/ketju, lämmin  
valkoinen, ei vaihdettava, kytketty 10  
LEDin sarjaan. Johto kirkas.

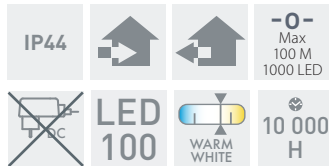

### DEL 5

LED-tilläggslinga med istappar 2,6 m  
Längd på den kabeldel som har lampor: 2,6  
m. 25 st. kedjor, kedjornas höjd: 20-50 cm.  
Avstånd mellan lamporna: 10 cm. 100 st.  
varmvita LED-lampor (2-5 st./kedja), ej  
utbytbara, kopplade i serie om tio lampor.  
Genomskinlig sladd.

Osa/ Del/ Part 5  
Kirkas/ Klar/ Clear

Nr 9477659



### PART 5

LED icicle extension set 2.6 m  
Length of the light unit 2.6 m, 25 chains,  
chain height 20-50 cm. LEDs at 10 cm  
intervals. LED 100 pcs: 2-5 pcs per chain,  
warm white, non-replaceable, connected  
with 10 LEDs in a series. Clear cord.

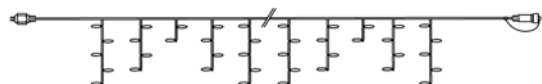

2,6 m x 20-50 cm

### OSA 7

LED partylisäsarja 19 m  
Valo-osan pituus 19 m, lamppuväli 1 m.  
Lamppusuojan koko vastaa vakiolampun  
koko. LED lämmin valkoinen, ei vaihdettava,  
kytketty 10 LEDin sarjaan. Johto musta tai  
kirkas.



### DEL 7

LED-tilläggslinga, party, 19 m  
Längd på den kabeldel som har lampor: 19 m.  
Avstånd mellan lamporna: 1 m. Lampkupans  
storlek motsvarar storleken på en standard-  
lampa. Varmvita LED-lampor, ej utbytbara,  
kopplade i serie om tio lampor. Svart eller  
genomskinlig sladd.

Osa/ Del/ Part 7  
Kirkas/ Klar/ Clear

Nr 9477661



### PART 7

Led party accessory 19 m  
Length of the light unit 19 m, lights at 1  
m intervals. The size of the bulb covering  
corresponds to the size of a standard  
bulb. LED warm white, non-replaceable,  
connected with 10 LEDs in a series.  
Black or clear cord

Osa/ Del/ Part 7  
Musta/ Svart/ Black

Nr 9477734



19 m

### OSA 8

Kirkas lamppusarja  
LED-sarja, jossa 20 kirkasta lamppua.  
Valo-osan pituus 19 m, lamppuväli 1 m.  
LED lämmin valkoinen, ei vaihdettava.  
Materiaali muovi. Johto tumma.



### DEL 8

Genomskinlig lampslinga  
En LED-slinga med 20 genomskinliga lampor.  
Längd på den kabeldel som har lampor 19  
m, avstånd mellan lamporna 1 m. Varmvita  
LED-lampor, ej utbytbara. Material: plast.  
Mörk sladd.

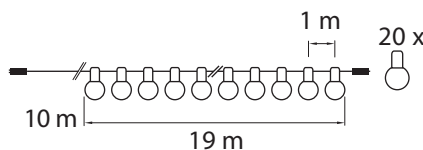

### PART 8

Clear lamp set  
A LED set of 20 clear lamps. Length of  
the light unit 19 m, lights at 1 m intervals.  
LED warm white, non-replaceable.  
Material: plastic. Dark cord.

Osa/ Del/ Part 8  
Musta/ Svart/ Black

Nr 9478588



### VALOMAA DISPLAY

Sisältää:  
Yhdet myyntierät osista 1-5 ja 7.  
Johto kirkas



Innehåller:  
Ett försäljningsparti av delarna 1-5 och 7.  
Genomskinlig sladd

Valomaa display

Nr 9477665



Contains:  
A single sales unit of parts 1-5 och 7.  
Clear cord



## GARDEN IP44 (230 V)

### JATKETTAVA LED-SARJA

Garden valosarjoissa on tukeva kumikaapeli, iskun- ja kosteudenkestävä rakenne. Perusvalosarjaan voi yhdistää enintään 24 lisävalosarjaa (1 + 24 valosarjaa) tai 1000 lediä, valo-osuuden pituus maks. 146 m. Perus- ja lisäsarjat on helppo liittää yhteen. Garden-sarjaa ei saa liittää muihin jatkettaviin led-sarjoihin.

### FÖRLÄNGBAR LED-SLINGA

Lampslingorna i serien Garden är utrustade med kraftiga gummikablar och är uppbyggda för att tåla stötar och fukt. Basslingan kan förlängas med upp till 24 extra lampslingor (1 + 24 lampslingor) eller 1 000 LED-lampor. Maximal längd för den delen av slingan som har lampor är 146 m. Det är enkelt att sammankoppla bas- och tillägsslingorna. Garden-slingan får inte kopplas till andra förlängbara LED-slingor.

### AN EXTENDABLE LED SET

The Garden set of lights has a robust rubber cable and a shock and moisture-proof structure. The basic unit can be connected to a maximum of 24 additional light series (1 + 24 light series) or 1,000 LEDs. The max. length of the light unit is 146 m. The basic unit and additional sets are easy to connect. The Garden set cannot be connected to other extendable LED series.

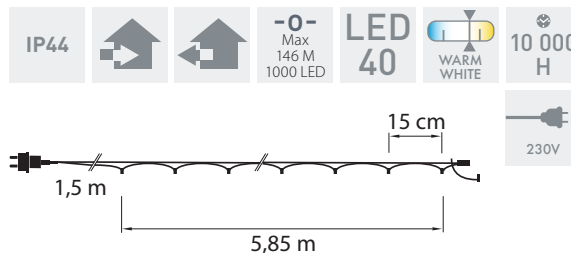

Perussarja/ Basserie/  
Starter set

Nr 9476720

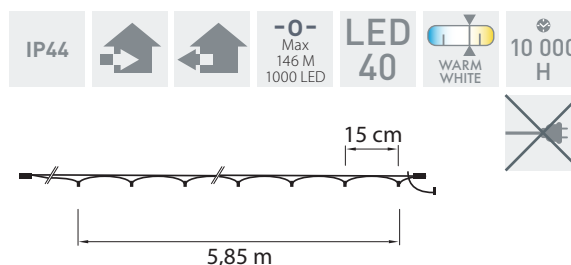

Lisäsarja/ Extraserie/  
Additional set

Nr 9476721





IP44			-0- Max 32,40 M 300 LED	LED 50		10 000 H
DC 31V 7,2W						

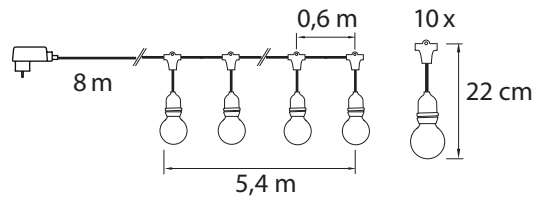

Perussarja/ Basserie/  
Starter set

Nr 9477962



## JARDIN IP44

### JATKETTAVA LAMPPUSARJA

Upea ja monikäyttöinen lamppusarja, jossa perussarjaan voi liittää jopa viisi lisäsarjaa. Ei saa kytkeä muihin valosarjoihin tai tuotteisiin, liitännät tulee sulkea huolellisesti. LED 50 kpl: 5 kpl/ lamppu, lämmin valkoinen, ei vaihdettava. Johto musta.

### FÖRLÄNGBAR LAMPSLINGA

Snygg och mångsidig lampslinga som kan förlängas med upp till fem tilläggsringor. Får inte kopplas till andra typer av ljusslingor eller produkter, kopplingarna bör stängas ordentligt. 50 st. varmvita LED-lampor (5 st./lampa), ej utbytbara. Svart sladd.

### AN EXTENDABLE SET OF LIGHTS

A magnificent and versatile set of lights, where the basic unit can be extended with five additional sets. Do not connect to other light sets or products. Secure the connections carefully. LED 50 pcs: 5 pcs/bulb, warm white, non-replaceable. Black cord.

1 x 9477962 + max. 5 x 9477963, max. total 32,40 m

IP44			-0- Max 32,40 M 300 LED	LED 50		10 000 H

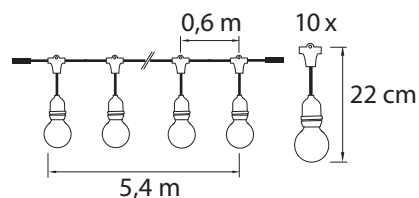

Lisäsarja/ Extraserie/  
Additional set

Nr 9477963





PUUT, ELÄINHAHMOT JA  
VALOKEHIKOT (IP44)

Träd, djur figurer & ljusram (IP44)  
Trees, Animal figures & Light frames (IP44)







#### TARJOLLA LOISTAVAA SEURAA!

Airamien led-valopuut ja -hahmot tekevät taatusti lähtemättömän vaikutuksen. Luo valopuilla kokonainen valometsä tai kutsu persoonallinen hahmo pihavahdiksi, parvekkeelle tai sisälle asti.

#### VI ERBJUDER STRÅLANDE SÄLLSKAP!

Airam's LED-ljusträd och -figurer ger garanterat ett bestående intryck. Skapa en hel skog av ljus med hjälp av ljusträden, eller bjud in en personlig figur som gårdsvakt, på balkongen eller ända in i huset.

#### BRIGHT NEW COMPANIONS!

Airam's LED light trees and figures are sure to make a lasting impression. Create an entire lighted forest with the trees or invite one of the quirky characters to look over your yard, sit on the balcony or even inside.

PUUT (IP44)

Träd (IP44)

Trees (IP44)



**NEW**

IP44

LED  
48WARM  
WHITE10 000  
H

DC 3V 3,6W

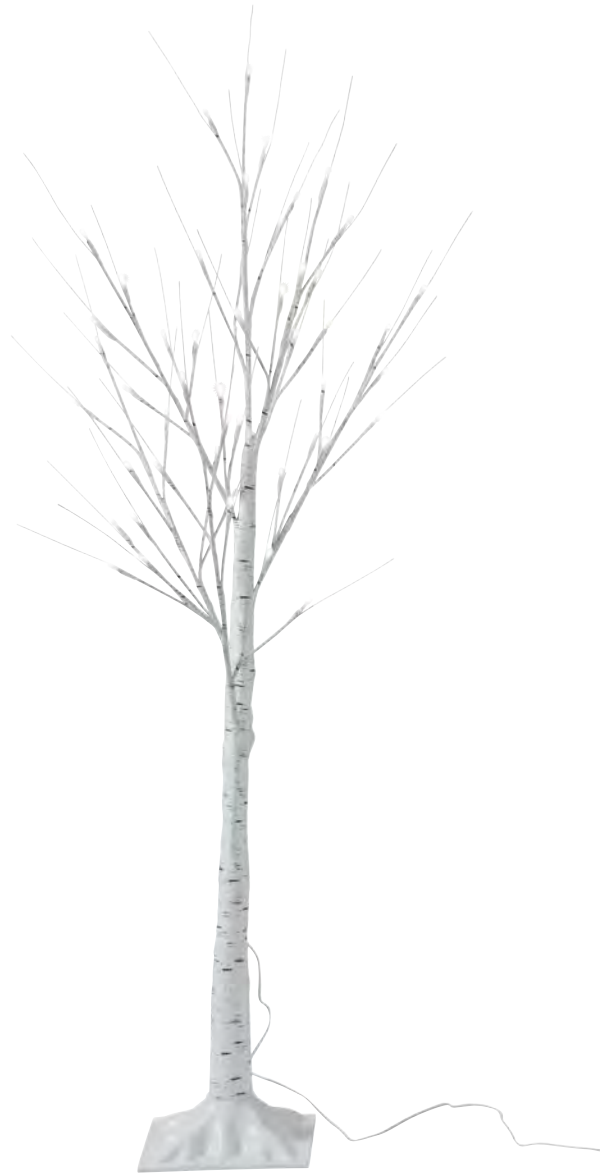

## BIRKE 1,2 M IP44

### LED-KOIVU

Kauniin valkoisen LED-koivun voi asettaa katettuun ulkotilaan, esim. parvekkeelle tai terassille. Puu luo tunnelmaa pimeneviin iltoihin. LED lämmin valkoinen, ei vaihdettava. Materiaali metalli ja muovi. Johto valkoinen.

### LED-BJÖRK

Den vackra LED-björken kan placeras utomhus under tak, t.ex. på en balkong eller terrass. Ett träd skapar stämning när kvällarna mörknar. Varmvita LED-lampor, ej utbytbara. Material: metall och plast. Vit sladd.

### LED BIRCH

The beautiful LED birch can be placed outdoors under a roof, e.g. in a balcony or terrace. A tree is cosy when evenings get darker. LED warm white, non-replaceable. Materials: metal and plastic. White cord.

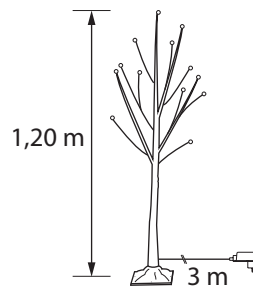

Nr 9478539



6 435200 248084



4

**NEW**

IP44

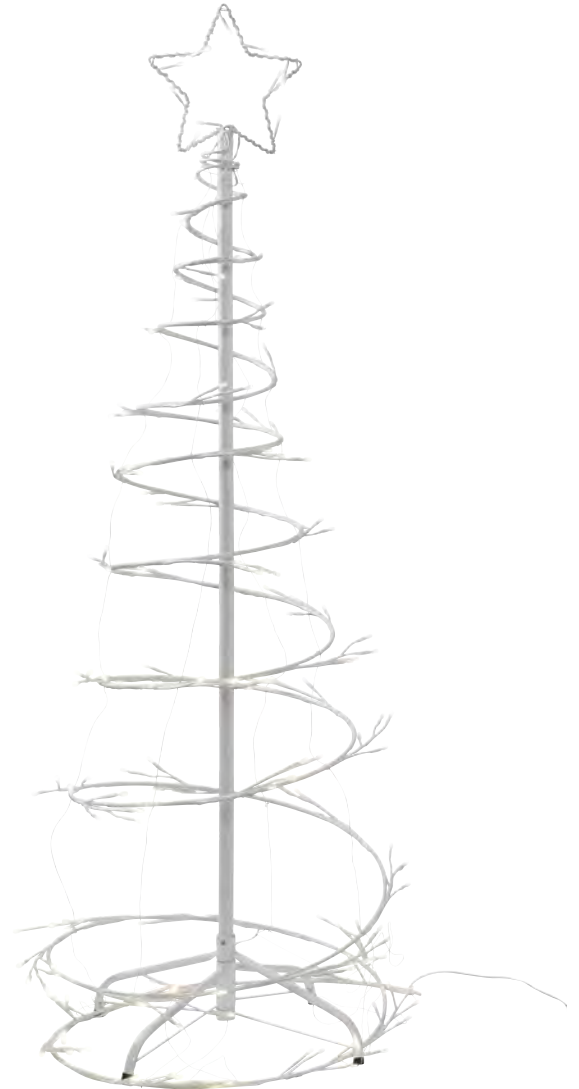
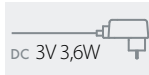
LED  
8910 000  
H

## SALIX 1,2 M IP44

### SPIRAALIPUU

Näyttävä valkoinen koristepuu, joka sopii moderniin sisustukseen ja myös ulkokäyttöön. Helposti kasattava: liitä puun keskelle tulevat putket yhteen ja aseta putki pystyyn spiraalin keskelle. Nosta spiraali keskikohdasta ylös. LED lämmin valkoinen, ei vaihdettava. Materiaali metalli. Johto valkoinen.

### SPIRALTRÄD

Ett imponerande vitt dekorationsträd för modern inredning och även utomhusbruk. Lätt att sätta ihop: sätt ihop de rör som kommer mitt i trädet och ställ ett rör mitt i spiralen. Ta i mitt i spiralen och lyft upp. Varmvita LED-lampor, ej utbytbara. Material: metall. Vit sladd.

### SPIRAL TREE

An impressive white decorative tree for modern interior design or outdoor use. Easy to put together: join the pipes in the middle of the tree and position the pipe upright in the middle of the spiral. Take hold of the middle of the spiral and lift it up. LED warm white, non-replaceable. Material: metal. White cord.

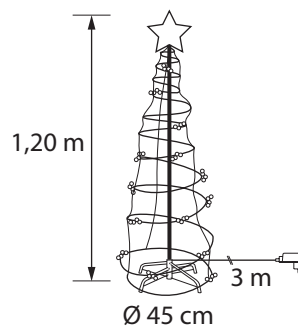

Nr 9478540



6 435200 248107



4

**NEW**

IP44

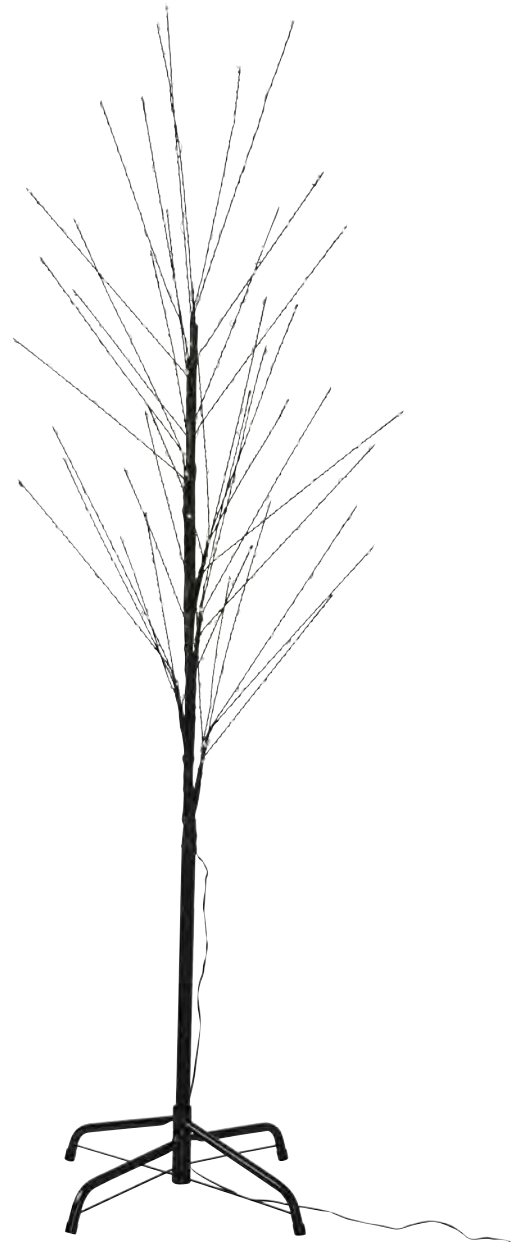
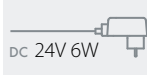
LED  
20010 000  
H

## BAUM 1,5 M IP44

### LED-PUU

Pienet pistemäiset ledit tekevät sirosta puusta erityisen kauniin. Oksia voi taivuttaa vapaasti, näyttävä myös oksat nipussa. Jalusta mukana pakkauksessa. LED lämmin valkoinen, ei vaihdettava. Materiaali metalli ja muovi. Johto tumma.

### LED-TRÄD

De små punktformiga LED-lamporna gör det sirliga trädet speciellt vackert. Kvistarna kan böjas fritt. Trädet är imponerande även med kvistarna ihop. Sockel medföljer. Varmvita LED-lampor, ej utbytbara. Material: metall och plast. Mörk sladd.

### LED TREE

The small point-sized LEDs make the graceful tree particularly beautiful. The twigs can be bent freely. The tree is impressive even with the twigs in bundles. A base is included. LED warm white, non-replaceable. Materials: metal and plastic. Dark cord.

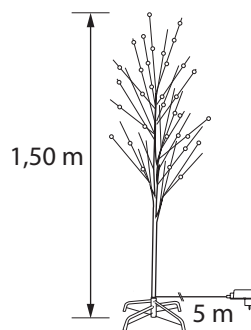

Nr 9478568





## KUKKAPUU 1,2 M IP44

LED-puu irrallisilla kukkasovitteilla (30 kpl) sekä jalustalla. LED lämmin valkoinen, ei vaihdettava, kytketty 10 LEDin sarjaan. Materiaali metalli ja muovi. Johto ruskea.

### BLOMMANDE LED-TRÄD IP44

LED-träd med löstagbara blomdekorationer (30 st.) och fot. Varmvita LED-lampor, ej utbytbara, kopplade i serie om tio lampor. Material: metall och plast. Brun sladd.

### LED FLOWER TREE IP44

An LED tree with removable flowers (30 pcs) and a base. LED warm white, non-replaceable, connected with 10 LEDs in a series. Material: metal and plastic. Brown cord.

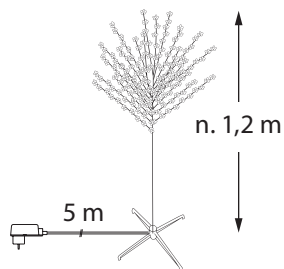

Nr 9477261





## JOULUKUUSET 1,5 M IP44

### LED-KUUSI

Materiaali tuuhea muovikuusi valkoisena tai vihreänä. Neulaset pysyvät suorina ja siistinä. Metallijalusta mukana. Valot valmiina kuusessa. LED lämmin valkoinen, ei vaihdettava, rinnankytketty. Johto kirkas tai musta.

### LED-GRAN

Vit eller grön, tät plastgran. Barren hålls raka och fina. Metallfot medföljer. Färdigmonterad belysning. Varmvita LED-lampor, ej utbytbara, parallellkopplade. Genomskinlig eller svart sladd.

### LED CHRISTMAS TREE

Lush plastic Christmas tree in white or green. The needles remain straight and neat. Comes with a metal stand. The tree includes lights. LED warm white, non-replaceable, parallel connection. Clear or black cord.

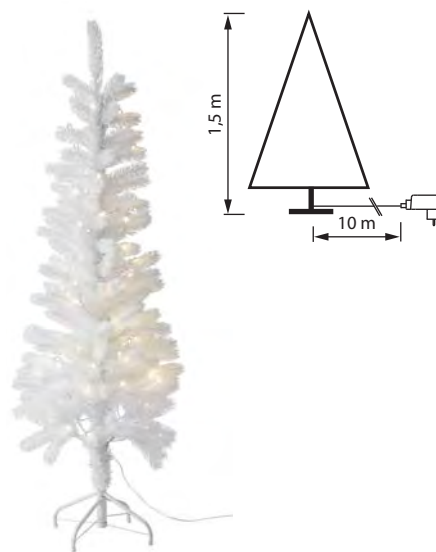

Valkoinen/ Vit/ White

Nr 9478047





## JOULUKUUSET 1,5 M IP44

### LED-KUUSI

Materiaali tuuhea muovikuusi valkoisena tai vihreänä. Neulaset pysyvät suorina ja siistinä. Metallijalusta mukana. Valot valmiina kuusessa. LED lämmin valkoinen, ei vaihdettava, rinnankytketty. Johto kirkas tai musta.

### LED-GRAN

Vit eller grön, tät plastgran. Barren hålls raka och fina. Metallfot medföljer. Färdigmonterad belysning. Varmvita LED-lampor, ej utbytbara, parallellkopplade. Genomsiktig eller svart sladd.

### LED CHRISTMAS TREE

Lush plastic Christmas tree in white or green. The needles remain straight and neat. Comes with a metal stand. The tree includes lights. LED warm white, non-replaceable, parallel connection. Clear or black cord.

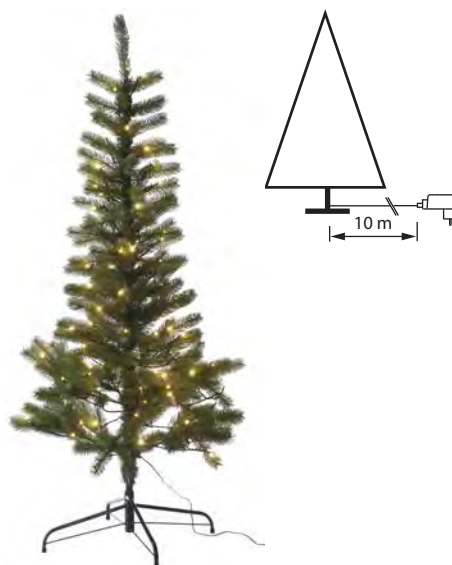

Vihreä/ Grön/ Green

Nr 9478048





ELÄINHAHMOT (IP44)

Figurer (IP44)

Figures (IP44)





## PANU IP44

### PINGVIINI

Selällään oleva pingviini nostattaa hymyn huulille ja luo letkeää tunnelmaa. Ulkokäytössä aseta hahmon alle alusta, joka estää sitä jäätymästä maahan kiinni. LED kirkas, ei vaihdettava. Johto kirkas.

### PINGVIN

Den liggande pingvinen ser rolig ut och skapar en lättäm stämning. Vid utomhusbruk: lägg ett underlag under pingvinen så att den inte fryser fast. Genomskinlig LED-lampa, ej utbytbar. Genomskinlig sladd.

### PENGUIN

The penguin lying on its back looks funny and creates a relaxed atmosphere. When used outdoors, place e.g. a mat under the penguin to keep it from freezing to the ground. LED clear, non-replaceable. Clear cord.

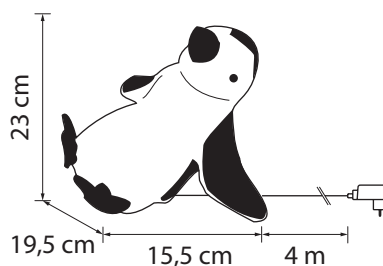

Nr 9478566



**NEW**

IP44

LED  
4010 000  
H

DC 3V 3,6VA



## ROBIN IP44

### LINTUSARJA

Valosarjassa on neljä isoa punatulkkua, jotka seisovat tukevasti omilla jaloillaan esim. ikkunalaudalla. Ulkokäytössä linnut voi helposti asetella oksalle tai pihakaiteelle. LED 40 kpl: 10 kpl/liintu, lämmin valkoinen, ei vaihdettava. Johto kirkas.

### FÅGELSLINGA

Ljusslingan har fyra stora domherrar som står stadigt på sina ben t.ex. på en fönsterbräda. Vid utomhusbruk kan fåglarna lätt placeras på en kvist eller ett räcke. LED 40 st.: 10 st./fågel, varmvita LED-lampor, ej utbytbara. Genomskinlig sladd.

### BIRD SERIES

The light series has four big bullfinches standing firmly on their feet, e.g. on a windowsill. When used outdoors, the birds can easily be placed on a twig or a rail. 40 LEDs: 10 LEDs per bird, warm white, non-replaceable. Clear cord.

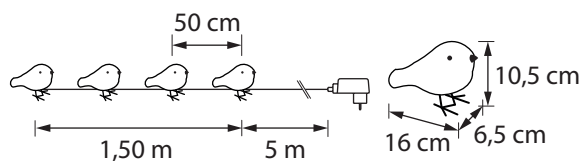

Nr 9478541



6 435200 248121



**NEW**

IP44

LED  
6410 000  
H

DC 24V 3,6W



## TEDDY IP44

### ISTUVA NALLE

Hellyttävä tonttupukuinen nalle istuu tukevasti esim. portaalla. Ulkokäytössä istuta nalle alustalle, jottei se jäädy kiinni. LED kirkas, ei vaihdettava. Johto kirkas.

### SITTANDE NALLE

En rörande nalle i tomtedräkt som sitter stadigt t.ex. på en trappa. Vid utomhusbruk: sätt nallen på ett underlag så att den inte fryser fast. Genomskinliga LED-lampor, ej utbytbara. Genomskinlig sladd.

### SITTING TEDDY BEAR

A sweet little teddy bear in a red costume sitting e.g. on a stair. When used outdoors, set the teddy bear e.g. on a mat to keep it from freezing to the ground. LED clear, non-replaceable. Clear cord.

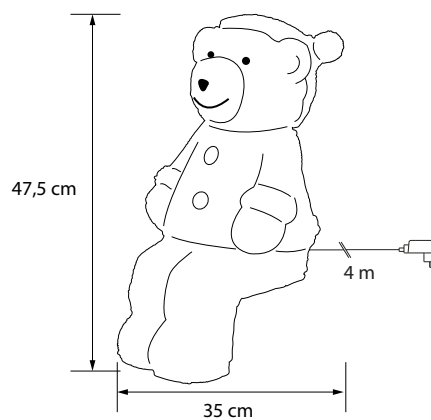

Nr 9478567



6 435200 250346



IP44

LED  
2410 000  
H

DC 24V 3,6W



## LED PUPU IP44

### ISTUVA

Suloinen istuva pupu. Ulkona LED-koristehahmon paras sijoi-  
tuspaiikka on katettu terassi tai katos. Jottei tuote jäädy maahan  
kiinni, aseta se esim. styrox-alustalle. LED kirkas, ei vaihdettava,  
kytketty 8 LEDin sarjaan. Materiaali muovi. Johto kirkas.

### SITTANDE LED KANIN

Söt, sittande kanin. Utomhus är en terrass med tak eller  
under annat utetak den bästa platsen för dekorationen. Placera pro-  
dukten t.ex. på ett underlag av frigolit för att den inte ska frysa  
fast i marken. Genomskinliga LED-lampor, ej utbytbara, kopplade  
i serie om åtta lampor. Material: plast. Genomskinlig sladd.

### SITTING LED BUNNY

A cute sitting bunny. Outside, the decorative LED figure is best  
placed on a covered patio or under an awning. To prevent the  
product from freezing to the ground, place it on a piece of  
Styrofoam or similar. LED clear, non-replaceable, connected with  
8 LEDs in a series. Material: plastic. Clear cord.

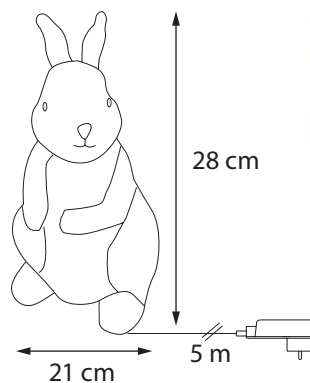

Nr 9477268



6 435200 188427





## BAMBI IP44

### LED-KORISTEHAHMO

Aseta suloinen Bambi ilahduttamaan parvekkeelle tai puutarhaan. Ulkona LED-koristehahmon paras sijoituspaikka on katettu terassi tai katos. Jottei tuote jäädy maahan kiinni, aseta se esim. styrox-alustalle. LED lämmin keltainen ja kirkas, ei vaihdettava, kytketty 10 LEDin sarjaan. Materiaali muovi. Johto kirkas.

### LED-DJURDEKORATION

Placera denna söta Bambi att sprida glädje på balkongen eller i trädgården. Utomhus är en terrass med tak eller under annat utetak den bästa platsen för dekorationen. Placera produkten t.ex. på ett underlag av frigolit för att den inte ska frysa fast i marken. Varmgula och klara LED-lampor, ej utbytbara, kopplade i serie om tio lampor. Material: plast. Genomskinlig sladd.

### LED DECORATION

Use the adorable Bambi to brighten up a balcony or garden, for example. Outside, the decorative LED figure is best placed on a covered patio or under an awning. To prevent the product from freezing to the ground, place it on a piece of Styrofoam or similar. LED warm yellow and clear, non-replaceable, connected with 10 LEDs in a series.

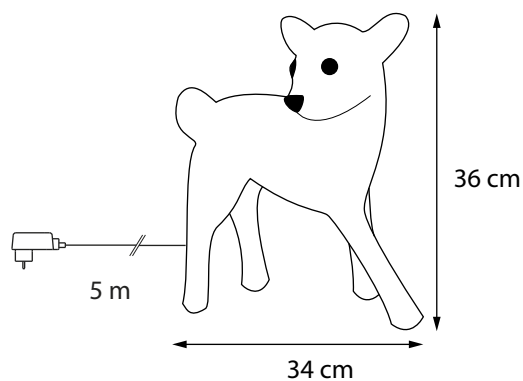

Nr 9477943





## PORO 90 CM IP44

### LED-KORISTEHAHMO

Suuri ja näyttävä poro ilahduttaa isommallakin terassilla. Ulkona LED-koristehahmon paras sijoituspaikka on katettu terassi tai katos. Jottei tuote jäädy maahan kiinni, aseta se esim. styrox-alustalle. LED kirkas, ei vaihdettava. Materiaali muovi/akryyli. Johto kirkas.

### LED-DJURDEKORATION

Denna stora och ståtliga ren sprider glädje även på en större terrass. Utomhus är en terrass med tak eller under annat utetäk den bästa platsen för dekorationen. Placera produkten t.ex. på ett underlag av frigolit för att den inte ska frysa fast i marken. Genomskinliga LED-lampor, ej utbytbara. Material: plast/akryl. Genomskinlig sladd.

### LED DECORATION

The large, magnificent reindeer will brighten up even larger patios. Outside, the decorative LED figure is best placed on a covered patio or under an awning. To prevent the product from freezing to the ground, place it on a piece of Styrofoam or similar. LED clear, non-replaceable. Material: plastic/acrylic. Clear cord.

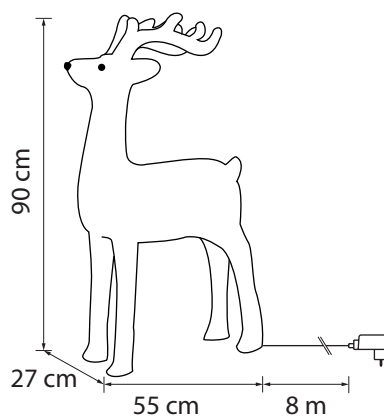

Nr 9478022





## ORAVA IP44

### LED-KORISTEHAHMO

Hauska orava-hahmo tuo valoa esim. parvekkeelle. Ulkona LED-koristehahmon paras sijoituspaikka on katettu terassi tai katos. Jottei tuote jäädy maahan kiinni, aseta se esim. styrox-alustalle. LED kirkas, ei vaihdettava. Materiaali muovi/akryyli. Johto kirkas.

### LED-DJURDEKORATION

Denna roliga ekorre sprider ljus t.ex. på balkongen. Utomhus är en terrass med tak eller under annat utetak den bästa platsen för dekorationen. Placera produkten t.ex. på ett underlag av frigolit för att den inte ska frysa fast i marken. Klara LED-lampor, ej utbytbara. Material: plast/akryl. Genomskinlig sladd.

### LED DECORATION

The fun, squirrel-shaped light can light up your balcony, for example. Outside, the decorative LED figure is best placed on a covered patio or under an awning. To prevent the product from freezing to the ground, place it on a piece of Styrofoam or similar. LED clear, non-replaceable. Material: plastic/acrylic. Clear cord.

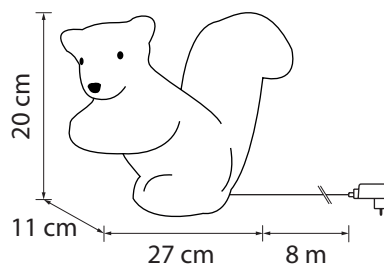

Nr 9478024







## KETTU IP44

### LED-KORISTEHAHMO

Aseta suloinen ja valpas kettu tarkkailemaan pihamaatasi. Ulkona LED-koristehahmon paras sijoituspaikka on katettu terassi tai katos. Jottei ketun hännänalus jäädy maahan kiinni, aseta se esim. styrox-alustalle. LED kirkas, ei vaihdettava. Materiaali muovi/akryyli. Johto kirkas.

### LED-DJURDEKORATION

Placera denna söta, vaksamma rävf att övervaka din trädgård. Utomhus är en terrass med tak eller under annat utetaken den bästa platsen för dekorationen. Placera produkten t.ex. på ett underlag av frigolit för att den inte ska frysa fast i marken. Klara LED-lampor, ej utbytbara. Material: plast/akryl. Genomskinlig sladd.

### LED DECORATION

Place the adorable and alert fox to monitor your yard. Outside, the decorative LED figure is best placed on a covered patio or under an awning. To prevent the fox from freezing to the ground, place it on a piece of Styrofoam or similar. LED clear, non-replaceable. Material: plastic/acrylic. Clear cord.

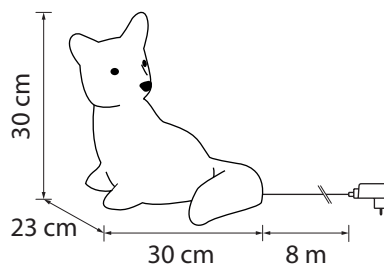

Nr 9478023



4



VALOKEHIKOT (IP44)

Ljusram (IP44)

Light frames (IP44)



**NEW**

IP44

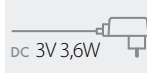
LED  
20010 000  
H

## HETA IP44

### VALOKEHIKKO

Suuri ja näyttävä tähdenmuotoinen valokehikko, jonka reunoille on kieputettu LED-sarja. Kehikon voi asettaa roikkumaan tai kiinnittää maahan. Pakkauksessa mukana 2 kpl maapiikkejä. LED lämmin valkoinen, ei vaihdettava. Materiaali metalli ja muovi. Johto tumma.

### LJUSRAM

En stor och imponerande stjärnformad ljusram med en LED-slinga över kanterna. Ramen kan hängas upp eller fästas i marken. Två piggar medföljer. Varmvita LED-lampor, ej utbytbara. Material: metall och plast. Mörk sladd.

### LIGHT FRAME

A large, impressive star-shaped light frame with a LED set around it. You can hang it up or fasten it to the ground with the two spikes included. LED warm white, non-replaceable. Materials: metal and plastic. Dark cord.

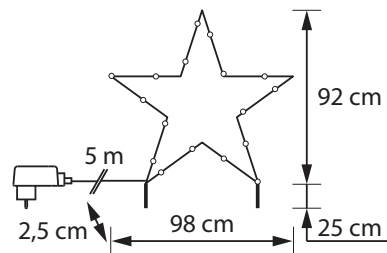

Nr 9478542



**NEW**

IP44

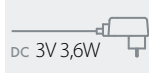
LED  
20010 000  
H

## HORTON IP44

### VALOKEHIKKO

Suuri ja näyttävä kuusenmuotoinen valokehikko, jonka reunoille on kieputettu LED-sarja. Kehikon voi asettaa roikkumaan tai kiinnittää maahan. Pakkauksessa mukana 2 kpl maapiikkejä. LED lämmin valkoinen, ei vaihdettava. Materiaali metalli ja muovi. Johto tumma.

### LJUSRAM

En stor, imponerande granformad ljusram med en LED-slinga över kanterna. Ramen kan hängas upp eller fästas i marken. Två piggar medföljer. Varmvita LED-lampor, ej utbytbara. Material: metall och plast. Mörk sladd.

### LIGHT FRAME

A large, impressive Christmas tree-shaped light frame with a LED set around it. You can hang it up or fasten it to the ground with the two spikes included. LED warm white, non-replaceable. Materials: metal and plastic. Dark cord.

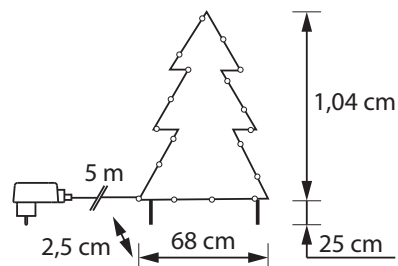

Nr 9478543





## HIUTAILE 55 CM IP44

### VALOKEHIKKO

Huikkea määrä LEDejä, joiden valo jakautuu tasaisesti koko silhuetin ympäri. LED lämmin valkoinen, ei vaihdettava, rinnankytketty. Materiaali metallikehikko, jossa paksu valonauha muodostaa hiutalekuvion. Johto kirkas.

### LJUSRAM

Produkt med enormt många LED-lampor som sprider ljus jämnt runt hela silhuetten. Varmvita LED-lampor, ej utbytbara, parallellkopplade. Material: metallstomme med en bred LED-strip som bildar en snöflinga. Genomskinlig sladd.

### LIGHT FRAME

An astounding number of LEDs whose light is distributed evenly across the entire silhouette. LED warm white, non-replaceable, parallel connection. Material: metal frame, where a thick string of lights creates the shape of a snowflake. Clear cord.

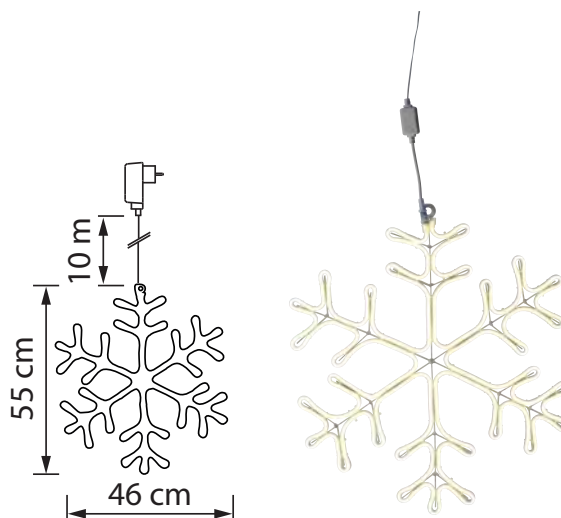

Nr 9478010





## PORO 85 CM IP44

### VALOKEHIKKO

Huikkea määrä LEDejä, joiden valo jakautuu tasaisesti koko silhuetin ympäri. LED lämmin valkoinen, ei vaihdettava, rinnankytketty. Materiaali metallikehikko, jossa paksu valonauha muodostaa porokuvion. Johto kirkas.

### LJUSRAM

Produkt med enormt många LED-lampor som sprider ljus jämnt runt hela silhuetten. Varmvita LED-lampor, ej utbytbara, parallellkopplade. Material: metallstomme med en bred LED-strip som bildar en ren. Genomskinlig sladd.

### LIGHT FRAME

An astounding number of LEDs whose light is distributed evenly across the entire silhouette. LED warm white, non-replaceable, parallel connection. Material: metal frame, where a thick string of lights creates the shape of a reindeer. Clear cord.

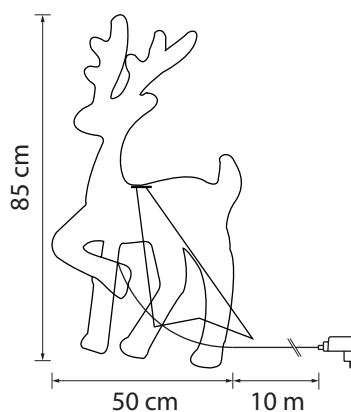

Nr 9478011





## TAMAR IP44

### LED-TÄHTI

Suureen tähteen pujotettu valolanka kajastaa kauniisti valoa. LED lämmin valkoinen, ei vaihdettava, rinnankytketty. Materiaali ohutta valkoista metallia. Johto kirkas.

### LED-STJÄRNA

Stor stjärna med ljusslinga som avger ett vackert ljusskimmer. Varmvita LED-lampor, ej utbytbara, parallellkopplade. Material: tunn, vit metall. Genomskinlig sladd.

### LED STAR

The string of lights threaded around a large star provides a beautiful shimmering light. LED warm white, non-replaceable, parallel connection. Material: thin white metal. Clear cord.

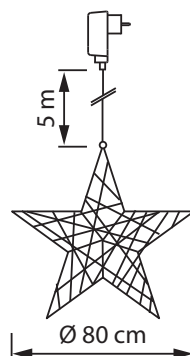

Nr 9477969





## ANETTE IP44

### VALOKEHIKKO

Upea, suuri valokruunu ilahduttaa esim. parvekkeilla ja terasseilla. LED lämmin valkoinen, ei vaihdettava, rinnankytketty. Metallikehys, jossa valonauhoja ja roikkuvia helmikoristeita (muovia). Johto kirkas.

### LJUSRAM

Underbar, stor ljuskrona för t.ex. balkonger och terrasser. Varmvita LED-lampor, ej utbytbara, parallellkopplade. Metallstomme med ljusslingor och hängande pärldekorationer (plast). Genomskinlig sladd.

### LIGHT FRAME

This magnificent, large light fixture is a delight on patios or balconies, for example. LED warm white, non-replaceable, parallel connection. A metal frame with light ribbons and hanging pearl decorations (made of plastic). Clear cord.

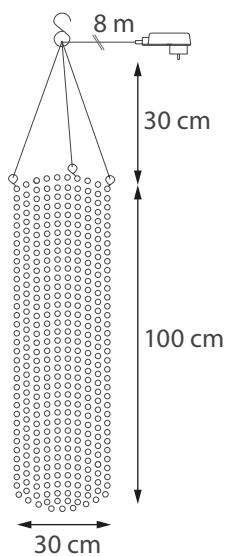

Nr 9476406





## VALOPROJEKTORIT

### Ljusprojektorer Light Projectors

#### HIENO ILOTULITUS, IHANA HILJAISUUS!

Projektorituotteilla luot juhliin ilotulitusmaista näyttävyyttä ilman ääntä. Heijasta liikkuvia kuvia kodin sisäseinille lasten sukkadis-kossa tai vietä lemmikkiystävällisempi uusivuosi heijastamalla valoshow vaikka terassin seinään.

#### FINF FYRVERKERI, SKÖN TYSTNAD!

Med Airam's projektorer kan du skapa fyrverkeristämning i en fest - utan ljud. Projicera rörliga bilder på väggar i hemmet när barnen har disco, eller fira ett djurvänligt nyår med en ljusshow på terrassväggen.

#### GREAT FIREWORKS, WONDERFUL SILENCE!

With Airam's projectors, you can create a firework atmosphere for your party - without any noise. Project moving pictures onto your walls for the kids' sock disco, or spend a pet-friendly New Year's Eve projecting a light show onto the terrace wall.



**NEW**

IP44

LED  
410 000  
H

DC 12V 6W



## LUMIHIUTALEARPROJEKTORI IP44

Sisälle tai katettuun ulkotilaan soveltuva projektori, joka heijastaa lumihiiutaleita ja tähtikuvioita pyörivällä liikkeellä. Heijastus n. 10 m<sup>2</sup> 3-5 m etäisyydeltä. Kääntyvä valo, joka voidaan lukita tiettyyn asentoon. Asennus joko kiinteästi ruuveilla tai maapiikillä. Valoa ei saa heijastaa suoraan silmiin. Ei lasten käyttöön. LED valkoinen, ei vaihdettava. Materiaali metalli ja muovi. Johto tumma.

### SNÖFLINGEPROJEKTOR IP44

En projektor som kan användas inomhus eller utomhus under tak. Den projicerar snöflingor och stjärnfigurer med en roterande rörelse. Projektion ca 10 m<sup>2</sup> på 3-5 m avstånd. Vändbart ljus som kan låsas i en ställning. Monteras antingen med skruvar eller en pigg i marken. Ljuset får inte riktas direkt mot ögon. Får inte användas av barn. Vit LED-lampa, ej utbytbar. Material: metall och plast. Mörk sladd.

### SNOWFLAKE PROJECTOR IP44

A projector for use indoors or outdoors under a roof. It projects snowflakes and star patterns with a rotating movement. Projection about 10 m<sup>2</sup> at a distance of 3-5 m. The light can be turned and locked in a certain position. To be fastened either with screws or a ground spike. Do not direct the light to eyes. Do not let children use the projector. LED white, non-replaceable. Materials: metal and plastic. Dark cord.



Lumihiiutaleprojektor

Nr 9478594



6 435200 250735



6

NEW

IP44

LED  
310 000  
H

DC 12V 6W



## VÄRIPISTEPROJEKTORI IP44

Tuo väri-iloittelua ja ilotulitetunnelmaa juhliin helposti! Sisälle tai katettuun ulkotilaan soveltuva projektori, joka heijastaa sinisiä, punaisia ja vihreitä väripisteitä pyörivällä liikkeellä. Heijastus n. 10 m<sup>2</sup> 3-5 m etäisyydeltä. Kääntyvä valo, joka voidaan lukita tiettyyn asentoon. Asennus joko kiinteästi ruuveilla tai maapiikillä. Valoa ei saa heijastaa suoraan silmiin. Ei lasten käyttöön. LED värimix, ei vaihdettava. Materiaali metalli ja muovi. Johto tumma.

### FÄRGPUNKTSPROJEKTOR IP44

Ett lätt sätt att få glada färger och fyrverkeristämning i en fest! En projektor som kan användas inomhus eller utomhus under tak. Den projicerar blåa, röda och gröna färgpunkter med en roterande rörelse. Projektion ca 10 m<sup>2</sup> på 3-5 m avstånd. Vändbart ljus som kan låsas i en ställning. Monteras antingen med skruvar eller en pigg i marken. Ljuset får inte riktas direkt mot ögon. Får inte användas av barn. LED färgmix, ej utbytbara. Material: metall och plast. Mörk sladd.

### COLOUR DOT PROJECTOR IP44

Add happy colours and firework atmosphere to a party easily! A projector for use indoors and outdoors under a roof. It projects blue, red and green colour dots with a rotating movement. Projection about 10 m<sup>2</sup> at a distance of 3-5 m. The light can be turned and locked in a certain position. To be fastened either with screws or a ground spike. Do not direct the light to eyes. Do not let children use the projector. LED colour mix, non-replaceable. Material: metal and plastic. Dark cord.



Väripisteprojektori

Nr 9478595



6 435200 250759



6



## VAIHTOKUVAPROJEKTORI IP44

Sisälle tai katettuun ulkotilaan soveltuva projektori, joka heijastaa kuvia pyörivällä liikkeellä. Mukana viisi erilaista kuviofilmiä, joita voi vaihtaa teeman tai juhla-kauden mukaan: hiutaleet, tähdet, sydämet, syntymäpäiväteema ja kaksi jouluaihetta. Heijastus n. 10 m<sup>2</sup> 3-5 m etäisyydeltä. Kääntyvä valo, joka voidaan lukita tiettyyn asentoon. Asennus joko kiinteästi ruuveilla tai maapiikillä. Valoa ei saa heijastaa suoraan silmiin. Ei lasten käyttöön. LED valkoinen, ei vaihdettava. Materiaali metalli ja muovi. Johto tumma.

### FIGURPROJEKTOR IP44

En projektor som kan användas inomhus eller utomhus under tak. Den projicerar figurer med en roterande rörelse. Med den följer fem olika figurfilmer som kan bytas enligt tema eller årstid: snöflingor, stjärnor, hjärtan, födelsedagstema och två julteman. Projektion ca 10 m<sup>2</sup> på 3-5 m avstånd. Vändbart ljus som kan låsas i en ställning. Monteras antingen med skruvar eller en pigg i marken. Ljuset får inte riktas direkt mot ögon. Får inte användas av barn. LED vita, ej utbytbara. Material: metall och plast. Mörk sladd.

### FIGURE PROJECTOR IP44

A projector for use indoors and outdoors under a roof. It projects figures with a rotating movement. It includes five different figure films that can be changed according to themes or seasons: snowflakes, stars, hearts, birthday theme and two Christmas themes. Projection about 10 m<sup>2</sup> at a distance of 3-5 m. The light can be turned and locked in a certain position. To be fastened either with screws or a ground spike. Do not direct the light to eyes. Do not let children use the projector. LED white, non-replaceable. Material: metal and plastic. Dark cord.

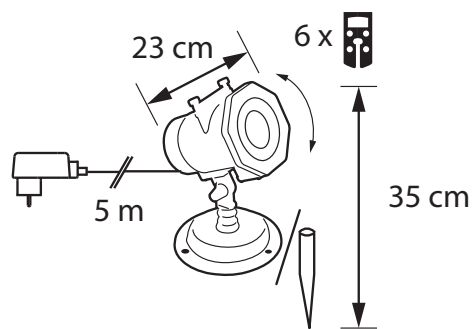

Vaihtokuvaprojektori

Nr 9478596



6 435200 250773





A close-up photograph of two glowing solar LED light bulbs hanging from a tree branch. The bulbs are clear glass with a silver base and are illuminated from within, casting a warm, yellowish glow. The background is filled with green leaves and other out-of-focus lights, creating a bokeh effect. The text "SOLAR LED" is overlaid on the left side of the image.

SOLAR LED



#### YHTEISTYÖSSÄ AURINGON KANSSA.

Airam ja aurinko tuovat valon vaikka sähköttömälle mökille. Loistava hahmo karkottaa pihan pimeät nurkat ja lyhdyt opastavat saunapolulla kulkijaa. Aurinkoenergialla toimivat tuotteet lataavat päivällä virtaa ja illan tullen hämäräkytkin sytyttää niihin valon, joka palaa aamuun asti. Ja silloinhan nousee taas aurinko.

#### I SAMARBETE MED SOLEN.

Airam och solen kan lysa upp en stuga som inte har el. En lysande gestalt jagar bort mörkret från trädgården och lyktor visar dig vägen till bastun. Produkter som fungerar med solenergi laddar ström på dagen, och på kvällen tändes skymningsreläet ett ljus som brinner hela natten. Och sedan är det ju morgon igen.

#### IN COOPERATION WITH THE SUN.

Airam and the sun can even light up a cottage with no electricity. A shining figure chases away the darkness from the yard, and lanterns show you the way to the sauna. Products powered by solar energy recharge current by day, and when the evening comes, the light-sensitive switch turns on the light that burns all night - until the sun takes over again.



## OPOLE

### SOLAR LED-SARJA

Solar LED-sarja, jossa 10 kpl kauniita palloja. Led 30 kpl: 3 kpl/pallo, lämmin valkoinen, ei vaihdettava. Mukana vaihdettava ja ladattava paristoakku. Materiaali muovi. Johto kirkas. On/off-kytkin.

### LED SOLCELLS-SERIE

En LED solcells-serie med 10 vackra transparenta bollar. 30 st varmvita LED-lampor (3 st/boll), ej utbytbara. Utbytbar och laddningsbart batteri ingår. Tillverkad av plast. Genomskinlig sladd. Av-/på-knapp.

### SOLAR LED SERIES

A Solar LED series with 10 beautiful balls. LED 30 pcs: 3 pc/ball, warm white, non-replaceable. Replaceable and rechargeable battery included. Material of plastic. Clear cord. On/off switch.

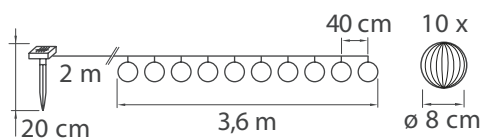

Nr 9477978







## KESÄ

### SOLAR LED-SARJA

Solar LED-sarja, jonka saa ripustettua näyttäviin asetelmiin. Lamppusuojojissa klassinen hehkulampun muoto. LED lämmin valkoinen, ei vaihdettava. Mukana vaihdettava ja ladattava paristoakku. Materiaali muovi. Johto kirkas. On/off-kytkin.

### LED SOLCELLS-SERIE

En LED solcells-serie som kan användas för att skapa spännande kombinationer och former. Lamphöljen i klassisk glödlampform. Varmvita LED-lampor, ej utbytbara. Utbytbar och laddningsbart batteri ingår. Tillverkad av plast. Genomskinlig sladd. Av-/på-knapp.

### SOLAR LED SERIES

A solar LED series that can be hung in impressive ways and combinations. The spheres have the classic bulb shape. LED warm white, non-replaceable. Replaceable and rechargeable battery included. Material of plastic. Clear cord. On/off switch.

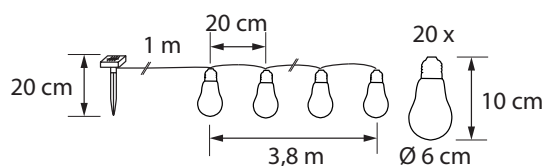

Nr 9477809





## HANNA

### SOLAR-PALLOSARJA

Itse koottava solar-sarja, jossa valkoiset ja harmaat pallot. LED lämmin valkoinen, ei vaihdettava. Mukana vaihdettava ja ladattava paristoakku. Materiaali nylon ja muovi. Johto kirkas. On/off-kytkin.

### LED SOLCELLS-SERIE

En LED solcells-serie med vita och grå mini-rislampor. Varmvita LED-lampor, ej utbytbara. Utbytbar och laddningsbart batteri ingår. Tillverkad av nylon och plast. Genomsiktig sladd. Av-/på-knapp.

### SOLAR LED SET

A ready-to-assemble solar set with white and grey balls. LED warm white, non-replaceable. Replaceable and rechargeable battery included. On/off switch.

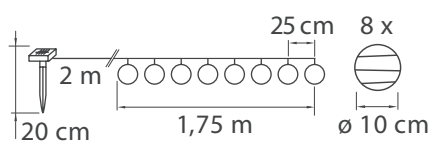

Nr 9477976



6 435200 233714





## KENJI & ERIKO

### SOLAR LED-LYHDYT

Ripusta ovaalilyhtyjä näyttäväksi ryhmäksi. LED lämmin valkoinen, ei vaihdettava. Mukana vaihdettava ja ladattava paristoakku. Materiaali nylon. On/off-kytkin.

### SOLAR LED-LYKTOR

Hängbara ovals LED-lyktor med eller utan grafiskt tryck. Varmvit LED-lampa, ej utbytbar. Utbytbar och laddningsbart batteri ingår. Tillverkad av nylon. Av-/på-knapp.

### SOLAR LED LANTERNS

Hang up oval lanterns to form an impressive group. LED warm white, non-replaceable. Replaceable and rechargeable battery included. Material of nylon. On/off switch.

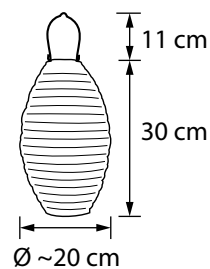

Kenji

Nr 9477973



6 435200 233677



Eriko

Nr 9477975



6 435200 234865



NEW

SOLAR  
LED



AUTOMATIC  
ON OFF

LED  
5

WARM  
WHITE

10 000  
H



## ROCKY

### RIPUSTETTAVA SOLAR-LAMPPULYHTY

Lampunmallinen solar-lyhty, jonka sisällä on LED-sarja. Ripusta vaikka useampi lamppu pihan piristykseksi! LED lämmin valkoinen, ei vaihdettava. Mukana ladattava nappiakuu, ei vaihdettava. Materiaali muovi.

### UPPHÄNGNINGSBAR SOLAR-LAMPLYKTA

En solar-lamplykta med LED-slinga inne i kupan. Häng upp flera lyktor för att skapa atmosfär eller för att navigera i trädgården vid mörker! LED varmvit, ej utbytbar. Laddningsbart knappbatteri ingår, ej utbytbar. Tillverkad av plast.

### HANG-ON SOLAR LAMP-LANTERN

A solar lamp-lantern with a LED set inside. Hang up several lamps to brighten up your garden! LED warm white, non-replaceable. Rechargeable button battery included, non-replaceable. Made of plastic.

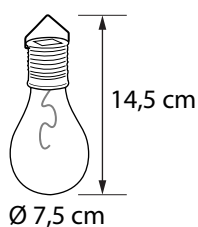

Nr 9478505





## APOLLO

### RIPUSTETTAVA SOLAR LED-LYHTY

Helposti ripustettava solar LED-koriste. LED lämmin valkoinen, ei vaihdettava. Mukana vaihdettava ja ladattava paristoakku. Materiaali muovi. On/Off-kytkin.

### UPPHÄNGNINGSBAR SOLAR LED-LYKTA

Modern LED-solcellslampa som är smidig att fästa i ögla eller med medföljande låsbar hake. Varmvita LED, ej utbytbara. Bytbart och laddningsbart batteri ingår. Tillverkad av plast. Av-/på-knapp.

### HANG-ON SOLAR LED LANTERN

A modern solar LED decoration, which is easy to hang up. LED warm white, non-replaceable. Replaceable and rechargeable battery included. Material of plastic. On/off switch.

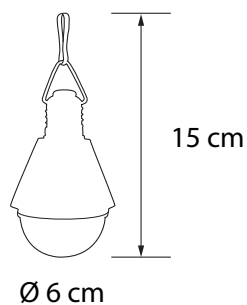

Nr 9476251





## MALIK

### RIPUSTETTAVA SOLAR-LAMPPULYHTY

Ripusta Industrial-henkinen lamppu terassin tai parvekkeen piristykseksi. LED lämmin keltainen, ei vaihdettava. Mukana vaihdettava ja ladattava paristoakku. Materiaali metalli ja muovi. On/off-kytkin.

### UPPHÄNGNINGSBAR SOLAR-LAMPLYKTA

Modern LED-solcellslampa som är smidig att fästa i ögla eller med medföljande låsbar hake. Varmvita LED, ej utbytbara. Bytbart och laddningsbart batteri ingår. Tillverkad av plast. Av-/på-knapp.

### HANG-ON SOLAR LAMP-LANTERN

Hang up the industrial style lamp to brighten up your terrace or balcony. LED warm yellow, non-replaceable. Replaceable and rechargeable battery included. Made of metal and plastic. On/off switch.

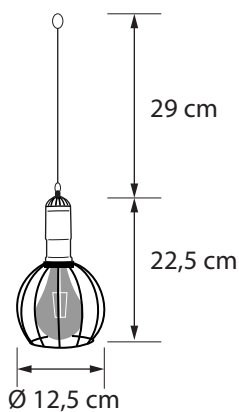

Nr 9478509





## ALPI

### SOLAR LED-LYHTY

Solar LED-lyhty, jonka sisällä kiinteä solar led-kynttilä. LED lämmin keltainen, ei vaihdettava. Mukana vaihdettava ja ladattava paristoakku. Materiaali muovi. On/off-kytkin.

### SOLAR LED-LYKTA

Dekorativ solcellslykta med fast LED-blockljus. Varmvit LED-lampa, ej utbytbar. Auto on/off. Utbytbar och laddningsbart batteri ingår. Tillverkad av plast. Av-/på-knapp.

### SOLAR LED LANTERN

A lantern with a fixed solar LED candle on the inside. LED warm yellow, non-replaceable. Replaceable and rechargeable battery included. Material of plastic. On/off switch.

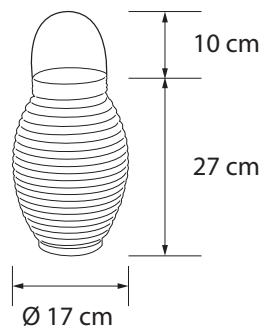

Nr 9477972





## DANI

### RIPUSTETTAVA SOLAR-LASILYHTY

Kaunis pieni solar lasilyhty, joka on erityisen näyttävä useamman lyhdyn ryhmässä. LED lämmin valkoinen, ei vaihdettava. Mukana vaihdettava ja ladattava paristoakku. Poista paristoakku suojaava liuska ennen käyttöä. Materiaali metalli ja lasi. On/off-kytkin.

### UPPHÄNGNINGSBAR SOLAR-GLASLYKTA

Vacker liten LED-solcellslykta som ger ett behagligt sken. Hängs med fördel i grupper om fler. Varmvit LED, ej utbytbar. Utbytbar och laddningsbart batteri ingår. Avlägsna materialet som skyddar batteriet innan användning. Tillverkad av glas och metall. Av-/på-knapp.

### HANG-ON SOLAR GLASS LANTERN

Beautiful small solar glass lanterns that look especially impressive when grouped together. LED warm white, non-replaceable. Replaceable and rechargeable battery included. Remove the slip protecting the battery. Material of glass and metal. On/off switch.

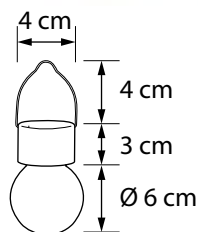

Nr 9477810







## DANI

### SOLAR-LASIPOLLARI

Kaunis maahan upotettava solar lasilyhty. Kenno-osa lasipallon sisällä, on/off-kytkin. Led 1 kpl lämmin valkoinen, ei vaihdettava. Mukana vaihdettava ja ladattava paristoakku. Materiaali metalli ja lasi. On/off-kytkin.

### SOLAR-GLASPOLLARE

Vacker LED-solcellspollare med markspjut. Solcellen är monterad inuti en skärm av glas med en på/av-knapp. Varmvit LED, ej utbyttbar. Byttbart och laddningsbart batteri ingår. Tillverkad av glas och metall. Av-/på-knapp.

### SOLAR GLASS BOLLARD

A beautiful solar glass lantern with integrated ground spike. The solar panel and the on/off switch are inside a glass sphere. LED warm white, non-replaceable. Replaceable and rechargeable battery included. Material of glass and metal. On/off switch.



Nr 9477811





## NEMO

### SOLAR-POLLARI

Klassinen solar-lyhty ohjaamaan kulkua pihapolulla tai reunustamaan kukkapenkkiä. LED lämmin valkoinen, ei vaihdettava. Mukana vaihdettava ja ladattava paristoakku. Materiaali metalli ja lasi. On/off-kytkin lasiosan sisällä.

### SOLAR-POLLARE

En klassisk LED-Solcellspollare som kan lysa upp gången eller dekorativt i en plantering. Varmvit LED, ej utbyttbar. Bytbar och laddningsbart batteri ingår. Tillverkad av metall och glas. Av-/på-knapp inuti glasdelen.

### SOLAR BOLLARD

A classic solar lantern to light the garden path or line a flower bed. LED warm white, non-replaceable. Replaceable and rechargeable battery included. Material of metal and glass. On/off switch inside the glass part.

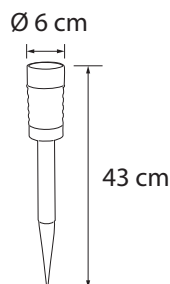

Nr 9477971



NEW

SOLAR  
LED



AUTOMATIC  
ON OFF

LED

WHITE

10 000  
H



## PALMER

### SOLAR-POLLARI

Solar-lyhdyssä on klassinen pyöreä muoto. Valo kajastaa kauniisti valkoisen kuvun sisältä. Maapiikki on jalkaosan sisällä. Led valkoinen, ei vaihdettava. Mukana ladattava nappiakku, ei vaihdettava. On/off-kytkin.

### SOLAR-POLLARE

Solar-lyktan har en klassisk rund form. Den vita kupan ger ett vackert ljus. Markspjutet finns i fotdelen. LED vit, ej utbytbar. Laddningsbart knappbatteri ingår, ej utbytbar. Av-/på-knapp.

### SOLAR BOLLARD

The solar lantern has a classic round shape. The white globe gives a beautiful light. The ground spike is in the foot part. LED white, non-replaceable. Rechargeable button battery included, non-replaceable. On/off switch.

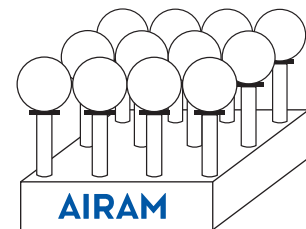
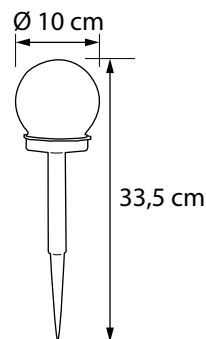

Nr 9478504





## LUCY

### SOLAR PYLVÄS

Kolmesta varsiosasta koostuvaa solar-pylvästä voi säätää kahteen eri mittaan käyttämällä joko kaikkia kolmea tai vain kahta varsiosaa. Helppo asentaa ja siirtää. LED kirkas, ei vaihdettava. Mukana vaihdettava ja ladattava paristoakku. Materiaali teräs, mattalasi ja muovi. On/off-kytkin.

### SOLCELLARMATUR

Solcellsarmatur med justerbar höjd i tre nivåer. Använd 2 eller 3 stolpdelar för den höjd som passar dig. Enkel att montera och flytta runt. Klar LED, ej utbyttbar. Bytbar och laddningsbar batteri ingår. Tillverkad av stål, matt glas och plast. Av-/på-knapp.

### A SOLAR COLUMN

A solar column consisting of three shaft sections that can be adjusted to two different lengths, using either all three or just two of the shaft parts. Easy to install and move around. LED clear, non-replaceable. Replaceable and rechargeable battery included. Material of steel, matte glass and plastic. On/off switch.

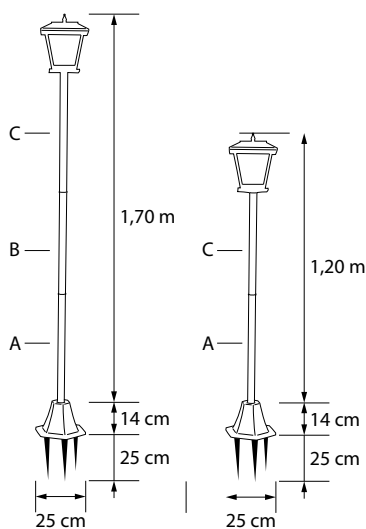

Nr 9477803



NEW

SOLAR  
LED



AUTOMATIC  
ON OFF

LED  
33



YELLOW  
elävä•living

10 000  
H

1x  
Ni-Mh  
AA  
600 mAh  
1,2V



## TIOGA

### SOLAR-LIEKKILYHTY

Solar-lyhdyssä on näyttävä liekkiefekti: valo lepattaa aidon liekin tavoin, mutta turvallisesti. Aurinkokenno lataa lyhtyyn virtaa päivisin on-asennossa. Hämäräkytkin sytyttää valon automaattisesti illalla. LED keltainen, ei vaihdettava. Mukana vaihdettava ja ladattava paristoakku. Materiaali muovi ja lasi. On/off-kytkin.

### SOLAR-LYKTA MED LEVANDE LÅGA

Solar-lyktan med levande låga, ljuset fladdrar som från ett riktigt ljus, men utan eld. När solcellen är på laddar den ström i lyktan under dagen. Skymningsreläet tänder ljuset automatiskt på vid skymning. LED gul, ej utbytbart. Utbytbart och laddningsbart batteri ingår. Tillverkad av plast och glas. Av-/på-knapp.

### FLICKERING SOLAR LANTERN

The solar lantern has an impressive flickering effect: the light flickers like a real flame, but safely. When the solar cell is on, it recharges the lantern in the daytime. The light-sensitive switch automatically turns on the light in the evening. LED yellow, non-replaceable. Replaceable and rechargeable battery included. Made of plastic and glass. On/off switch.

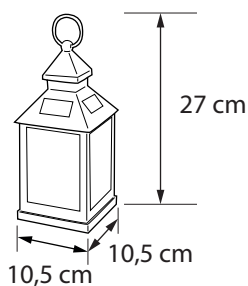

Nr 9478503



**NEW****SOLAR  
LED****AUTOMATIC**  
ON OFF**LED  
33****YELLOW**  
elävä-living**10 000  
H****1x  
Ni-Mh  
AA  
600 mAh  
1,2V**

## LESTER

### SOLAR-LIEKKIPOLLARI

Solar-pollarissa on näyttävä liekkiefekti: valo lepattaa aidon liekin tavoin, mutta turvallisesti. Luo tunnelmaa pihapolulle tai puutarhaan. Aurinkokenno lataa lyhtyyn virtaa päivisin on-asennossa. Hämäräkytkin sytyttää valon automaattisesti illalla. LED keltainen, ei vaihdettava. Mukana vaihdettava ja ladattava paristoakku. Materiaali muovi. On/off-kytkin.

### SOLAR-POLLARE MED LEVANDE LÅGA

Solar-lyktan med levande låga, ljuset fladdrar som från ett riktigt ljus, men utan eld. Skapar stämning vid altanen eller i trädgården. När solcellen är på laddar den ström i lyktan under dagen. Skymningsreläet tänder ljuset automatiskt vid skymning. LED gul, ej utbytbar. Utbytbar och laddningsbart batteri ingår. Tillverkad av plast. Av-/på-knapp.

### FLICKERING SOLAR BOLLARD

The solar bollard has an impressive flickering effect: the light flickers like a real flame, but safely. Creates an atmosphere by the path or in the garden. In the daytime when the solar cell is on, it recharges the lantern. The light-sensitive switch automatically turns on the light in the evening. LED yellow, non-replaceable. Replaceable and rechargeable battery included. Made of plastic. On/off switch.

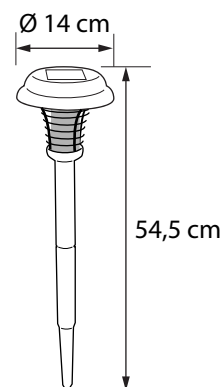

Nr 9478502



6 435200 245885





## KARHU

### SOLAR KORISTE

Hauska karhu toivottaa vieraat tervetulleiksi. Welcome -teksti kajastaa pehmeästi valoa solar-energian voimalla. LED kirkas, ei vaihdettava. Mukana vaihdettava ja ladattava paristoakku. Materiaali lasikuitu ja muovi. On/off-kytkin.

### SOLAR-BJÖRN

En skojig björn som hälsar gästerna välkomna. Ordet Welcome lyser sobert med sollceller och batteri. Klara LED-lampor, ej utbytbara. Utbytbar och laddningsbart batteri ingår. Tillverkad av glasfiber och plast. Av-/på-knapp.

### SOLAR BEAR

A funny bear to welcome your guests. The word Welcome shines softly with solar energy. LED clear, non-replaceable. Replaceable and rechargeable battery included. Material of fibreglass and plastic. On/off switch.

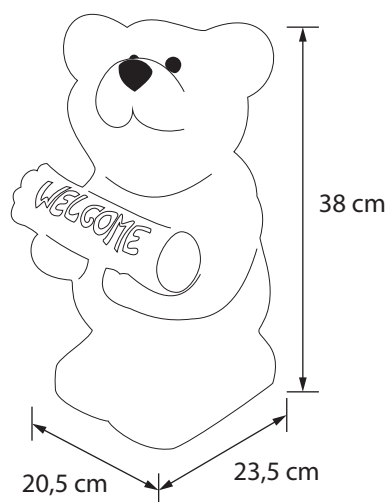

Nr 9477982





## PANDA

### SOLAR-KORISTE

Suloinen solar panda ilahduttaa ja syö väsymättä bambua vehreällä pihamaallasi. Led 2 kpl: 1 kpl/silmä, kirkas, ei vaihdettava. Mukana vaihdettava ja ladattava paristoakku. Materiaali lasikuitu ja muovi. On/off-kytkin.

### SOLAR-PANDA

En söt panda som gör dig glad var den än placeras i din trädgård eller bostad. 2 st klara LED-lampor (1 st/öga), ej utbytbara. Utbytbart och laddningsbart batteri ingår. Tillverkad av glasfiber och plast. Av-/på-knapp.

### SOLAR PANDA

A cute little solar panda cheering you up and always eating bamboo in your garden. LED 2 pcs: 1 pc/eye, clear, non-replaceable. Replaceable and rechargeable battery included. Material of fibreglass and plastic. On/off switch.

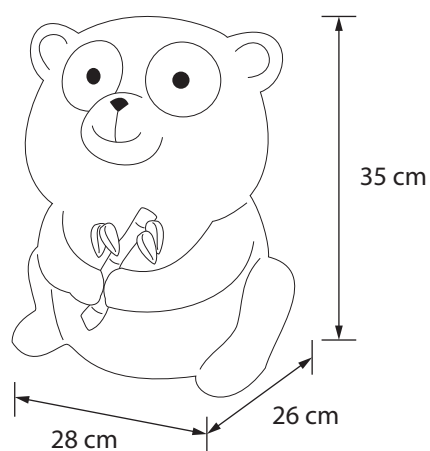

Nr 9477981







## SAMMAKKO

### ISO SOLAR-KORISTE

Hauska, iso solar LED-sammakko ilahduttaa puutarhassa. LED 2 kpl: 1 kpl/silmä, valkoinen, ei vaihdettava. Mukana vaihdettava ja ladattava paristoakku. Materiaali lasikuitu ja muovi. On/off-kytkin.

### STOR DEKORATIONSGRODA MED SOLCELLER

Stor dekorationsgroda med solceller för att liva upp i trädgården. 2 st vita LED-lampor (1 st/öga), ej utbytbara. Utbytbar och laddningsbart batteri ingår. Tillverkad av glasfiber och plast. Av-/på-knapp.

### LARGE SOLAR LED FROG

A fun, large solar LED frog. A delight in the garden. LED 2 pcs: 1 pc/eye, white, non-replaceable. Replaceable and rechargeable battery included. Material of fiberglass and plastic. On/off switch.

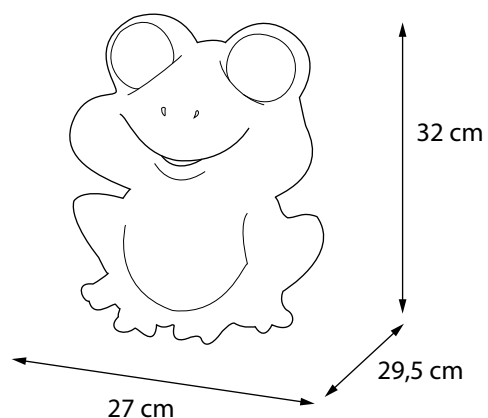

Nr 9477802





## ORAVA

### ISO SOLAR-KORISTE

Iso solar LED-orava tuo iloa pihalle tai terassille. LED 2 kpl: 1 kpl/silmä, valkoinen, ei vaihdettava led. Mukana vaihdettava ja ladattava paristoakku. Materiaali lasikuitu ja muovi. On/off-kytkin.

### STOR DEKORATIV EKORRE MED SOLCELLER

Stor dekorativ ekorre med solceller och lysande ögon för att utsmyska gården eller terrassen. 2 st vita LED-lampor (1 st/öga), ej utbytbara. Utbytbar och laddningsbart batteri ingår. Tillverkad av glasfiber och plast. Av-/på-knapp.

### LARGE SOLAR LED SQUIRREL

A large solar LED squirrel that brings delight to the yard or terrace. LED 2 pcs: 1 pc/eye, white, non-replaceable. Replaceable and rechargeable battery included. Material of fibreglass and plastic. On/off switch.

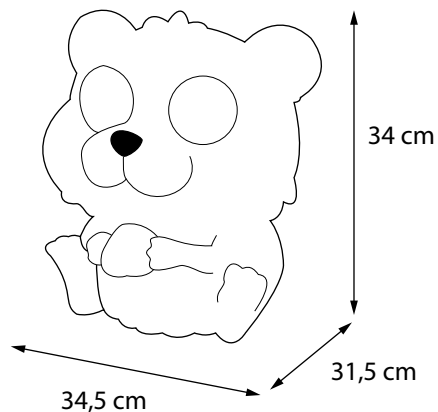

Nr 9477799





## PÖLLÖ

### ISO SOLAR-KORISTE

Upea, suuri solar LED-pöllö pihan piristykseksi. LED 2 kpl: 1 kpl/silmä, lämmin valkoinen, ei vaihdettava. Mukana vaihdettava ja ladattava paristoakku. Materiaali muovi. On/off-kytkin.

### STOR DEKORATIONSUGGLA MED SOLCELLER

Praktfull Uggle med LED-ögon och solceller för gårdsdekoration. 2 st varmvita LED-lampor (1 st/öga), ej utbytbara. Utbytbar och laddningsbart batteri ingår. Tillverkad av plast. Av-/på-knapp.

### LARGE SOLAR LED OWL

A gorgeous, large solar LED owl to spice up the yard. LED 2 pcs: 1 pc/eye, warm white, non-replaceable. Replaceable and rechargeable battery included. Material of plastic. On/off switch.

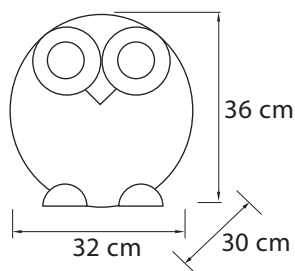

Nr 9477781





Paristoakut  
NI-MH 2/3 AA 100 mAh 1,2V

Nr 9476205



NI-MH AA 300 mAh 1,2V

Nr 9476203



NI-MH AAA 300 mAh 1,2V

Nr 9476204



NI-MH AA 600 mAh 1,2V

Nr 9476207



## PARISTOAKUT

Solar led-tuotteiden ladattavat nikkelimetallihydridiparistoakut voi vaihtaa vastaavaan uuteen. Akkuja voidaan käyttää myös muissa ladattavissa tuotteissa, joissa on vastaavat tiedot ja arvot.

### UPPLADDNINGSBARA BATTERIER

Uppladdningsbara och utbytbara nickel-metallhydrid-solarbatterier. Batterierna kan också användas med uppladdningsbara produkter med motsvarande specifikationer och värden.

### RECHARGEABLE BATTERIES

The rechargeable nickel-metal hydride batteries of the solar LED products can be replaced with new ones. The batteries can also be used in other appropriate rechargeable products.

NI-MH AAA 600 mAh 1,2V

Nr 9476206



NI-MH AA 700 mAh

Nr 9476208



LI-ION AA 600 mAh 3,2V

Nr 9476209



# VARALAMPUT | RESERVLAMPOR | SPARE BULBS

01

16 sisä- ja ulkosarjat nk. Kuusen-  
kynttilät/ indoor and outdoor  
sets, so-called Christmas tree  
candles

3W 14V PIKYP E10/3BL

Nr 4719242



6 435200 000996



20

17

Talli-, majakka- ja kynttilälyhty,  
minilamppu/ Oil lamp, lighthou-  
se and candle lantern, minibulb

0,475W 5V MINI/5BL

Nr 4710114



6 435200 123558



20

54

Kynttiläsarjat (4/5)/ Candle sets  
(4/5)

3W 55V PIK E10/3BL

Nr 4719257



6 435200 000989



20

55

Kynttiläsarjat (7)/ Candle sets (7)

3W 34V PIK E10/3BL

Nr 4719254



6 435200 000972



20

56

Kynttiläsarjat (7) liekki/ Candle  
sets (7) flame

3W 34V PIK E10/3BL

Nr 4711737



6 435200 010995



20

57

JIS6 ikkunasarja 230V ns. imu-  
kuppisarja/ JIS6 window set 230  
V, so-called suction cup set

3W 20V PIKYP E10/3BL

Nr 4719248



6 435200 001009

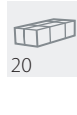

20

58

Talli-, majakka- ja kynttilälyhty  
(isot)/ Oil lamp, lighthouse and  
candle lantern (large)

3W 23V PIK E10/3BL

Nr 4719251



6 435200 000965



20

59

Kynttiläsarjat (16)/ Candle sets  
(16)

3W 14V PIK E10/3BL

Nr 4719245



6 435200 000958



20

60

Sisä- ja ulkosarjat 30 nk. Kuusen-  
kynttilät/ Indoor and outdoor  
sets 30, so-called Christmas tree  
candles

3W 8V PIKYP E10/3BL

Nr 4779302



6 435200 121387



20

84

Jouluikkuna, kynttilätalo ja -ket-  
ju, kyntteliköt, imukuppikynttilä-  
sarja/ Christmas window, candle  
house and chain, candelabra,  
suction cup candle set

2W 24V E10/3BL

Nr 4719968



6 435200 121721



20

93

LED-kuusenynttiläsarja/ LED  
Christmas tree candle set \*

8-34V 0,2W E10,

Nr 9477012



6 435200 142955



5

98

LED lamppu matta valkoinen/  
Spare LED matte white (7 kpl/  
pcs/blister) \*

8-34V 0,2W E10

Nr 9477710



6 435200 157355



10

99

LED lamppu matta keltainen/  
Spare LED matte yellow (7 kpl/  
pcs/blister) \*

8-34V 0,2W E10

Nr 9477736



6 435200 163998



10

102

LED lamppu keltainen/ Spare  
LED yellow (3 kpl/pcs/blister) \*

8-55V E10 PIK

Nr 9477325



6 435200 186898



10

103

LED lamppu keltainen/ Spare  
LED yellow (7 kpl/pcs/blister) \*

8-55V E10 PIK

Nr 9477324



6 435200 187079



10

106

LED lamppu/ Spare LED bulb  
(Kajo) \*\*/\*\*

5W E27

Nr 9477322



6 435200 217721



5

\* Led-lamppua ei saa käyttää muissa led-tuotteissa, ellei led-lampun tiedot ole vastaavat. Ei saa kytkeä sekaisin led-lampuja ja muita hehkulamppuja. Vain muuntajallisiin Airam-tuotteisiin.

\* LED-lampan får inte användas i andra LED-produkter om inte LED-lamporna har motsvarande uppgifter. LED-lampor och andra glödlampor får inte kopplas om vartannat. Endast för Airam-produkter med transformator.

\* The LED bulbs cannot be used in other LED products, unless the information of the LED bulb correspond to the product specifications. LED bulbs and other bulbs cannot be connected together. Only to be used with Airam products with transformers.

\*\* Suositellaan käytettäväksi vain Kajo led-lamppusarjassa.

\*\* Används enligt rekommendation endast i LED-lampslingan Kajo.

\*\* Only recommended for use with the Kajo LED set.

# AAKKOSELLINEN HAKEMISTO

## ALFABETISK INNEHÅLLSFÖRTECKNING

### ALPHABETICAL TABLE OF CONTENTS

&	37	Candy	69
Seinäkoriste/ Väggedekoration/ Wall hanging		Pallosarja/ Bollserie/ Ball set	
2in1	52	Ceres IP44	83
Koristetähti/ Dekorationsstjärna/ Decorative star		Kranssi/ Krans/ Wreath	
Adela	24-25	Cindy	108
Koristesarjat/ Dekorations slingor/ Light chains		LED-vahakynttilät/ Ljus i vax/ wax candles	
Alpi Solar	239	Clara	97
Lyhty/ Lykta/ Lantern		Lasipallo/ Glasboll/ Glass sphere	
Amor Roosa nauha sydän -Ikkunakoriste/ Rosa Bandet Fönsterdekoration/ Pink Ribbon Window hanging	9	Clarion	118
Ananas	56	Loimulyhty/ Flammande lykta/ Flaming lantern	
Koristevalosarja/ Dekorations slinga/ Decorative set		Dani Solar	240-
Anette IP44	224	Lyhdyt/ Lyktor/ Lanterns	241
LED-kruunu/ krona/ chandelier		Data	40
Anne	74	Kirjain- ja numerotaulu/ Bokstavs- och siffertavla/ Letter and numeral board	
Helmisydän/ Pärlhjärta/ Pearl heart		Data	41
Apollo Solar	237	Kirjoitustaulu ja kynä/ Skrivtavla och penna/ Writing board with pen	
Lyhty/ Lykta/ Lantern		Delux 16 & 30 IP44	143
Arima	110	Kuusenkynttiläsarja/ Julgransbelysning/ Christmas tree light set	
Kynttiläprojektori/ Kynttiläprojektori/ Kynttiläprojektori		Delux 16 IP20	142
Aurora	144	Kuusenkynttiläsarja/ Julgransbelysning/ Christmas tree light set	
Kauko-ohjattavat kuusenkynttilät/ Fjärrstyrd julgransbe- lysning/ Remote-controlled Christmas tree candles		Delux display 64	142
Avon IP44	167	Duo 100 IP44	15
LED-lamppusarja/ lampslinga/ lamp set		LED-sarja/ LED-slinga/ LED chain	
Bambi IP44	214	Edith	80
LED-koristehahmo/ djurdekoration/ decoration		Sydän/ Hjärta/ Heart	
Baum	205	Eiffel IP44	191
LED-puu/ träd/ tree		LED-latvasarjat/ toppslingor/ Flagpole sets	
Bea	86	Eimi IP44	174
Paperitähti/ Pappersstjärna/ Paperstar		LED-koristepallo/ dekorationsboll/ decoration ball	
Berit	54	Eini	121
Pöytäkoriste/ Bordsdekoration/ Table decoration		LED-lyhty/ lykta/ lantern	
Birke	203	Elbe IP44	148-
LED-koivu/ björk/ birch		LED-sarjat/ LED-slingor/ LED chains	149
Bitti	87	Ella	57
Paperitähti/ Pappersstjärna/ Paperstar		Kimallesarja/ Glitterslinga/ Glitter set	
Book	88	Elli	20
Paperiviuhka/ Papperssolfjäder/ Paper fan		Pullovero/ Flaskljus/ Bottle light	
Box	48	Eriko Solar	235
Koristepaketit/ Dekorationspaket/ Decorative gift packages		Lyhty/ lykta/ lantern	
Cairo IP44	190	Estero IP44	188
LED-latvasarja/ toppslinga/ Treetop set		Valokoriste/ Valokoriste/ Valokoriste	
Camino	120	Evelyn	60
Koristetakkalyhty/ Braslykta/ Fireplace lantern		Tähtisarja/ Stjärnslinga/ Star set	
		Fantasia	51
		Koristeovi/ Dekorationsdörr/ Decorative door	

Frida Köynnös/ Girlang/ Vine	42	Jutta LED-vahakynttilä/ Ljus i vax/ wax candle	107
Gam Lasilintu/ Glasfågel/ Glass bird	101	Kaili IP44 LED-tähtiverho/ stjärngardin/ star curtain	187
Garden IP44 (230 V) Jatkettava LED-sarja/ Förlängbar LED-slinga/ An extendable LED set	197	Kaisa Lasitorni/ Glastorn/ Glass spire	98
Gen IP44 LED-köysi/ rep/ rope	176	Kajo IP44 LED-lamppusarja/ lampslinga/ lamp set	165
Grace LED-kynttelikkö/ Ljusstake/ candelabra	123	Kathrin LED-kynttelikkö/ Ljusstake/ candelabra	124-125
Halloween kurpitsa/ Halloweenpumpa, orange/ Halloween pumpkin, orange	10	Katja LED-sarja/ slinga/ light chain	58
Hanna Solar LED-sarja/ serie/ series	234	Keira IP44 LED-lamppusarja/ lampslinga/ lamp set	164
Hans Valolankasarja/ Decorationsslinga/ Light chain	28	Kelly Lasienkelisarja/ Ljusslinga med glasänglar/ Glass angel set	100
Havu 30 cm Pöytäkuusi/ Bordsgran/ Spruce	46	Kenji Solar Lyhty/ lykta/ lantern	235
Heta IP44 Tähtivalokehikko/ Ljusram/ Light frame	219	Kesä Solar LED-sarja/ serie/ series	233
Hilda Lasienkeli/ Glasängel/ Glass angel	99	Kettu IP44 LED-koristehahmo/ djurdekoration/ decoration	217
Hile Paperitähtisarja/ Ljusslinga med pappersstjärnor/ Paper star set	92	Kiia IP44 Jääpuikkosarja/ LED-slinga med istappar/ Icicle light set	180
Hile Ø 26 cm Paperitähti/ Pappersstjärna/ Paper star	91	Kimmel Kuusenkynttiläsarja/ Julgransbelysning/ Christmas tree light set	140
Hiutale 55 cm IP44 Valokehikko/ Ljusram/ Light frame	221	Kruunukynttilät/ LED-kronljus/ candles	12
Hopeakurpitsa/ Halloweenpumpa, silver/ Halloween pumpkin, silver	10	Kukkapuu IP44/ Blommande LED-träd IP44/ LED flower tree IP44	206
Hopeakäpy IP44 LED-sarja/ slinga/ light chain	59	Kulma IP44 LED-verkko/ nät/ net	192
Horton IP44 Kuusivalokehikko/ Ljusram/ Light frame	220	Kurpitsasarja IP44 Halloweenserie/ Halloween series	11
Huvi IP44 LED-lamppusarja/ lampslinga/ lamp set	169	Lace Hiutalesydän/ Snöflingehjärta/ Snowflake heart	76
Hypnos Tähti/ Stjärna/ Star	73	LED havuköynnös 40 IP44/ girlang/ fir twig vine	44
Hypnos Ympyrä/ Cirkel/ Circle	72	LED havuköynnös 50 IP44/ girlang/ fir twig vine	45
Ice IP44 Tähtisarjat/ Ljusslinga med stjärnor/ Light chains with stars	157	LED jääpuikkoketjut IP44/ LED-ljuskedjor med istappar/ LED icicle light chains	182
Jardin IP44 Jatkettava lamppusarja/ Förlängbar lampslinga/ An extendable set of lights	198	LED Pupu IP44 LED-koristehahmo/ djurdekoration/ decoration	213
Jenni LED-vahakynttilä/ Ljus i vax/ wax candle	106	LED valolankaryhmä IP44, hopea/ Grupp av LED-trådslingor, silver/ LED light wire set, silver	31
Joulukuuset 1,5 m IP44/ Gran/ Christmas tree	207-208	LED valolankaryhmät IP44, kupari/ Grupp av LED-trådslingor, koppar/ LED light wire sets, copper	32
Joulupukki suosittelee teline/ Produktställning/ Product stand	135	LED valolankasarja, hopea/ LED-trådslinga, silver/ LED light wire, silver	22
Juno Latvatähti/ Toppstjärna/ Treetop star	138	LED valolankasarja, kupari/ LED-trådslinga, koppar/ LED light wire, copper	23

LED-ikkuna/ fönster/ window	132	Minisarja 40/ Dekorationsslinga/ Decorative mini-light-set	61
LED-ikkunasarja/ LED-fönsterslinga/ LED window set	14	Minni 20	64
LED-kuusenkynttiläsarja/ Julgransbelysning/ Christmas tree light set	134	Lankapallot/ Trådbollar/ Cotton balls	
LED-latvatähti, hopea/ Toppstjärna, silver/ Treetop star, silver	133	Moment	77
LED-minikynttilä/ miniljus/ mini candles	113	Ikkunatähti/ Fönsterstjärna/ Window star	
LED-minikynttiläteline/ miniljus ställning/ mini candle display	113	Muisto 12 cm	115
LED-sarjojen Irtojohto/ Skarvsladd/ Extension cord	159	Hautakynttilä ristikuviolla/ Gravljus med korsmonster/ Memorial candle with crosses	
LED-vahakyynttilä/ LED-ljus i vax/ LED wax candle	109	Muisto 13 cm	116
LED-verkot IP44/ nät/ nets	193	Hautakynttilä hämäräkytkimellä/ Gravljus med skymnings- sensor/ Memorial candle with a dusk switch	
Ledia	152-	Nappi	21
LED-sarjat/ LED-slingor/ LED chains	153	Valolanka/ Trådslinga/ Light wire	
Leena	79	Nashua	162
LED-joulutähdet/ julstjärnor/ Christmas stars		LED-lamppusarja/ lampslinga/ lamp set	
Leena	79	Nemo Solar	242
Metallitähdteline/ Ställning med metallstjärnor/ Metal star display		Lyhty/ Lykta/ Lantern	
Lester Solar	246	Neptus	163
Liekkipollari/ Pollare med levande låga/ Flickering bollard		LED-lamppusarja/ lampslinga/ lamp set	
Liana	78	Nico	127
LED-tähti/ stjärna/ star		LED-kynttelikkö/ ljustake/ candelabra	
Lisa IP44	139	Niili IP44	33
Latvatähti/ Toppstjärna/ Treetop star		Kierresarja/ Spiralslinga/ Spiral cord set	
Love	39	Norte IP44	168
Seinäkoriste/ Väggedekoration/ Wall hanging		LED-lamppusarja/ lampslinga/ lamp set	
Lucy Solar	244	Nuoli	36
Pylväs/ Armatur/ Column		Seinäkoriste/ Väggedekoration/ Wall hanging	
Lunar IP44	181	Oili	75
Jääpuikkosarja/ LED-slinga med istappar/ Icicle light set		Helmitähti/ Pärlstjärna/ Pearl star	
Lunar IP44	154	Opole Solar	232
LED-sarja, superkirkas/ LED-slinga, mycket klar/ LED set, super bright		LED-sarja/ serie/ series	
Malik Solar	238	Orava IP44	216
Lyhty/ Lykta/ Lantern		LED-koristehahmo/ djurdekoration/ decoration	
Marion	81	Oula	47
Kranssi/ Krans/ Wreath		Koristepuu/ Dekorationsträd/ Decorative tree	
Marit	96	Palmer Solar	243
Lasisydän/ Glashjärta/ Glass heart		Pollari/ Pollare/ Bollard	
Mary	50	Paloma IP44	177
Enkeli/ Ängel/ Angel		LED-naruverkko/ nät/ string net	
Mea	19	Panu	210
Valolanka/ Trådslinga/ Light wire		LED-koristehahmo/ djurdekoration/ decoration	
Milja 10	65	Paperitähden johto/ Ljusslinga till pappersstjärna/ Cord for the paper star	93
Lankapallot/ Trådbollar/ Cotton balls		Paris IP44	171
Milja 20	68	Koristevalo/ Dekorationslamppa/ Ornamental lamp	
Lankapallot/ Trådbollar/ Cotton balls		Paula	122
Milja 6 Ø15 cm	66	LED-kynttelikkö/ ljustake/ candelabra	
Lankapallot/ Trådbollar/ Cotton balls		Pecos IP44	166
Milja 6 Ø20 cm	67	Koristelamppusarja/ Dekorationslampslinga/ Decorative lamp set	
Lankapallot/ Trådbollar/ Cotton balls		Petra	53
		LED-tähti/ stjärna/ star	
		Pihla Ø 43 cm	89
		Paperitähti/ Pappersstjärna/ Paper star	



Pilke Ø 100 cm Paperitähti/ Pappersstjärna/ Paper star	90	Solar Sammakko/ Gråda/ Frog	249
Pilvi Seinäkoriste/ Väggedekoration/ Wall hanging	38	Suomi valolanka/ LED-trådslinga/ LED light wire	13
Point USB Valonauha/ Ljusband/ light strip	18	Taiga IP44 RGB LED-pallosarja/ LED-bollslinga med RGB-funktion/ RGB LED sphere set	156
Poro 85 cm IP44 Valokehikko/ Ljusram/ Light frame	222	Tallilyhty IP44 LED-lyhty/ oljelykta/ oil lamp	170
Poro 90 cm IP44 LED-koristehahmo/ djurdekoration/ decoration	215	Tamar IP44 Valokehikko/ Ljusram/ Light frame	223
Retro 16 Kuusenkynttiläsarja/ Julgransbelysning/ Christmas tree light set	141	Team IP44 LED-sarjat/ LED-slingor/ LED chains	150- 151
Rioni IP44 LED-latvasarja/ toppslinga/ Treetop set	189	Teddy LED-koristehahmo/ djurdekoration/ decoration	212
Rita IP44 LED-lamppu/ lampa/ lamp	175	Tellus Metallipallo/ Metallkula/ Metal Ball	55
Robin Lintusarja/ Fågelslinga/ Bird series	211	Telma IP44 LED-jääkideverho/ gardin med iskristaller/ ice crystal chain	186
Rocky Solar Lamppulyhty/ Lamplykta/ Lamp-lantern	236	Tempo LED-vahakynttilä/ ljus i vax/ wax candle	105
Ronja Hopeahelmisarja/ Serie med pärlor/ Series with pearls	30	Teno IP44 LED-sarjat/ LED-slingor/ LED chains	158
Roosa nauha lankapallot/ Rosa Bandet Dekorationsslinga/ Pink Ribbon cotton ball series	8	Tinja LED-vahakynttilä/ ljus i vax/ wax candle	104
Ruby LED-lyhtykynttilä/ Lyktljus/ Lantern candle	114	Tioga Solar Liekilyhty/ Lykta med levande låga/ Flickering lantern	245
Saana Kidesarja/ Ljusslinga med kristaller/ Crystal ball light chain	27	Trinity IP44 LED-hiutaleverho/ Gardin med snöflingor/ Snowflake curtain	185
Saana Koristesarjat/ Dekorationsslingor/ Light chains	26	Trio Koristepakettisarja/ Dekorationspaketslinga/ Set of Deco- rative gift packages	49
Saga Loimulyhty/ Flammande lykta/ Flaming lantern	119	Unicorn Valolankasarja/ Dekorationsslinga/ Light chain	29
Saimi Kukkaköynnös/ Kukkaköynnös/ Kukkaköynnös	43	Valomaa IP44 Jatkettava LED-sarja/ Förlängbar LED-slinga/ An exten- dable LED set	195- 196
Salix Spiraalipuu/ Spiralträd/ Spirial tree	204	Valoprojektorit/ Ljusprojektorer/ Light Projectors IP44	225- 229
Sally LED-vahakynttilät/ ljus i vax/ wax candles	112	Varalamput/ Reservlampor/ Spare bulbs	253
Sandra LED-kynttilät/ ljus/ candles	131	Vesta 20 IP44 LED-jääpuikkoketjut/ kedjor med istappar/ icicle light chains	183
Serata Loimulyhty/ Flammande lykta/ Flaming lantern	117	Vesta 40 IP44 LED-jääpuikkoketjut/ kedjor med istappar/ icicle light chains	184
Sheila LED-kynttelikkö/ Ljusstake/ candelabra	126	Visio IP44 Flashlight LED-sarja/ LED-slinga/ LED chain	155
Silja LED-kynttelikkö/ Ljusstake/ candelabra	128- 129	Wanda Kranssi/ Krans/ Wreath	82
Solar Karhu/ Björn/ Bear	247	Winter 16 & 30 IP44	145
Solar Orava/ Ekorre/ Squirrel	250	Kuusenkynttiläsarja/ Julgransbelysning/ Christmas tree light set	145
Solar Panda	248	Xena LED-vahakynttiläsetti/ Ljusset i vax/ wax candles	111
Solar paristoakut/ Uppladdningsbara batterier/ Rechar- geable batteries	252		
Solar Pöllö/ Uggle/ Owl	251		

# AIRAM



Airam Electric Oy Ab Sementtitehtaankatu 6 04260 Kerava vaihe 0207 545 600 www.airam.fi	Airam AB Uppköparvägen 7 120 44 Årsta, Sverige Telefon +46 8 72 244 20 (växel) Fax +46 8 60 283 00 info@airam.se www.airam.se	Airam Electric Oy Ab P.O. Box 175 (Sementtitehtaankatu 6) FI-04201 Kerava Finland Tel. +358 207 545 600 fax +358 207 545 623 export@airam.fi www.airam.fi
Postiosoite: Airam Electric Oy Ab PL 175 04201 Kerava		

## TEAM FINLAND

Tilaukset sähköpostitse		tilaukset@airam.fi
Tilaukset faksilla	0207 545 624	
Tilaukset / Asiakaspalvelu	0207 545 617	asiakaspalvelu@airam.fi
Tilaukset / Asiakaspalvelu	Kristiina Juvonen 0207 545 613	kristiina.juvonen@airam.fi
Tilaukset / Asiakaspalvelu	Anette Juvonen 0207 545 622	anette.juvonen@airam.fi
Tilaukset / Asiakaspalvelu	Tiina Vahtera-Jäppilä 0207 545 615	tiina.vahtera-jappila@airam.fi
Myyntijohtaja PT	Kari Niemenmaa 0400 729 408	kari.niemenmaa@airam.fi
PT avainasiakkaat Etelä- ja Länsi-Suomi	Ari Tihinen 040 745 6142	ari.tihinen@airam.fi
PT avainasiakkaat Itä- ja Pohjois-Suomi	Keijo Tikkanen 040 508 3908	keijo.tikkanen@airam.fi
PT Etelä-Suomi	Kalle Rautio 040 132 5442	kalle.rautio@airam.fi
PT Länsi-Suomi	Taneli Leppäniemi 044 738 9794	taneli.leppaniemi@airam.fi
PT Pohjois-Suomi	Pekka Järvelä 0400 461 181	pekka.jarvela@airam.fi
PT myyntiassistentti	Sanna Helenius-Kiiski 0400 229 140	sanna.helenius-kiiski@airam.fi
Markkinointijohtaja	Minna Hellström 040 802 1076	minna.hellstrom@airam.fi
Kuvat ja myymälämateriaali	–	mediabank.airam.fi
Reklamaatiot/laadunvalvonta	040 551 4962	asiakaspalaute@airam.fi

## TEAM SVERIGE/SWEDEN

CEO/VD	Niclas Steén	+46 (0)8 722 44 20	niclas.steen@airam.se
Kundtjänst	Monica Larsson	+46 (0)70 263 74 44	monica.larsson@airam.se
Kundtjänst	Lina Vitulic	+46 (0)8 722 44 20	lina.vitulic@airam.se
Kundtjänst, allmänna frågor och information		+46 (0)8 722 44 20	info@airam.se
Ljusdesign, allmänna frågor och information		–	ljusdesign@airam.se
Säljteam, teknisk belysning, hembelysning, ljuskällor, fritidsprodukter, retail	Gerry Glyré	+46 (0)70 826 99 00	gerry.glyre@airam.se
Säljteam, OEM, teknisk belysning, hembelysning och ljuskällor, retail och grossist	Joakim Karlsson	+46 (0)73 088 66 11	joakim.karlsson@airam.se
Säljteam, teknisk belysning, grossist, installatör	Jesper Vikberg	+46 (0)70 567 64 34	jesper.vikberg@airam.se
Säljteam, teknisk belysning, grossist, installatör	Lars Landgren	+46 (0)79 341 02 92	lars.landgren@airam.se
Säljteam, försäljning fackhandel - hembelysning, ljuskällor och fritidsprodukter	Lennart Andersson	+46 (0)70 593 07 49	lennart.andersson@airam.se
Säljteam, försäljning fackhandel - hembelysning, ljuskällor och fritidsprodukter	Magnus Siljedahl	+46 (0)70 360 23 95	magnus.siljedahl@airam.se
Säljteam, försäljning fackhandel - hembelysning, ljuskällor och fritidsprodukter	Pernilla Bärnsten	+46 (0)72 965 37 28	pernilla.barnsten@airam.se

## TEAM EXPORT

Customer service		–	export@airam.fi
Sales	Marika Jääskeläinen	+358 40 658 2170	marika.jaaskelainen@airam.fi
Sales	Kalle Kärki	+358 40 635 2175	kalle.karki@airam.fi

**Tuotteen käyttö**  
**Användning av produkt**  
**Use of the product**

IP20		IP20 Sisäkäyttöön IP20 För inomhusbruk IP20 For indoor use
IP44		IP44 Sisä- ja ulkokäyttöön IP44 För inom- och utomhusbruk IP44 For indoor and outdoor use

**Valonlähde**  
**Ljuskälla**  
**Light source**

	kpl / st / pcs
	Varalamppu Reservlampa Spare bulb
	Myydään erikseen Säljs separat Additional product

**Valon väri / Polttoikä**  
**Ljus färg / Brinntid**  
**Light colour / Hours**

	Valon sävy Ljus nyans Light shade
	Valon väri Ljus färg Light colour
	RGB-LED Colour mix
	Vaihtaa väriä Byter färg Changing colour
	Polttoikä Brinntid Burning hours

**Lisäominaisuus**  
**Additional feature**  
**Additional feature**

	Eläväliekkunen tai leimuva LED Fladdrande & levande LED Flickering & living LED
	Hämärytkin Skymningssensor Dusk switch
	Ajastin Timer
	Kaukosäädin Fjärrkontrol Remote control
	Vilkkuva LED Blinkande LED Blinking LED

**Virtalähde**  
**Strömförsörjning**  
**Power supply**

	Paristo- /akkukäyttöinen: määrä/tyyppi Batteridrivnen/laddningsbart batteri: mängd/typ Battery operated/rechargeable: Qty/type
	Toimii muuntajalla: Voltti / teho Transformer: Volt / effekt Driver: Voltage / power
	Jatkettavuus (metriä) Länkbarhet (meter) Extendable (meters)
	Verkkovirta 230V + teho (W) Växelström 230V + effekt (W) Mains voltage 230V + wattage (W)
	Aurinkokenno Solcell Solar cell
	USB

**Pakkaus / Myyntierä**  
**Förpackning / FRP**  
**Package type / Sales unit**

	Hyllypakkaus Hyllförpackning Shelf packaging
	Riippupakkaus Spjutförpackning Hanging packaging
	Pöytäeline Bordsställning Table stand
	Myymläteline Ställning Sales stand

**Lisätieto**  
**Mera information**  
**Additional info**

	Uutuus Nyhet Novelty
	Joulupukki suosittelee Jultomten rekommenderar Recommended by Santa Claus
	Myyntissä vain Suomessa Säljs endast i Finland Only available in Finland



**SER-KIERRÄTYS**

Käytöstä poistetut sähkö- ja elektroniikkalaitteet ovat sähkö- ja elektroniikkalaiteromua.

Laitteista otetaan talteen raaka-aineita ja materiaaleja. Näin kerättyä materiaalia uudelleenkäytetään ja hyödynnetään. Laitteiden palautus on maksutonta SER-kierrätyspisteisiin (kts. SER-keräyspisteet [www.kierratys.info](http://www.kierratys.info)). Tuotteen pakkaus tulee poistaa ja viedä se joko pahvi- tai muovipakkausten keräyspisteeseen.

**EE-ÅTERVINNING**

Kasserade elektriska och elektroniska produkter är el- och elektronikavfall.

Av produkterna tar man vara på råvaror och material. Material som på så sätt samlats in återanvänds och utnyttjas. Man får kostnadsfritt lämna in sådana produkter till miljöstationer för EE-avfall (se SER-keräyspisteet på [www.kierratys.info](http://www.kierratys.info)). Produktförpackningen bör avlägsnas och lämnas till insamling av antingen papp- och kartong- eller plastförpackningar.

**WEEE RECYCLING**

Discarded electrical and electronic equipment is waste electrical and electronic equipment.

Raw and other materials from such equipment are reclaimed. These materials are recycled and utilized. Discarded appliances can be returned free of charge to WEEE recycling sites (see SER-keräyspisteet at [www.kierratys.info](http://www.kierratys.info)). The product packing should be removed and taken to a site either for discarded cardboard or plastic.

# Koristevalot | Dekorationsbelysning | Decorative Lights 2019

Airam Electric Oy Ab  
P.O. Box 175  
(Sementtitehtaankatu 6)  
FI-04201 Kerava, Finland  
Tel. +358 207 545 600  
Fax +358 207 545 623  
info@airam.fi  
International customer  
service: export@airam.fi  
www.airam.fi

Airam AB  
Uppköparvägen 7  
120 44 Årsta, Sverige  
Telefon +46 8 72 244 20 (växel)  
Fax +46 8 60 283 00  
info@airam.se  
www.airam.se

© Airam Electric Oy Ab, 2019

Pidätämme oikeuden muutoksiin.  
Vi förbehåller oss rätten till eventuella  
ändringar och tryckfel.  
Product related changes possible.



# AIRAM